

Ecophon Focus™ A

Ecophon Focus™ A has an exposed grid system with easily demountable tiles. For applications where a robust suspended ceiling system is required. Improves absorption in the low frequency range, Ecophon Extra Bass can be installed on top of the suspended ceiling.



DSB Werkbedrijf, Nijmegen, Netherlands

SYSTEM RANGE

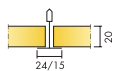

Size, mm	600x600	600x600	625x625	1200x600	1200x1200	1250x625	XL 1600x600	XL 1800x600	XL 1800x600	XL 2000x600	XL 2000x600	XL 2400x600
Connect T15	•	•		•	•							
Connect T24	•	•	•	•	•	•	•	•	•	•	•	•
T24	•	•		•	•							
Thickness (THK)	20	20	20	20	20	20	20	20	20	20	20	20
Inst. Diagr.	M01, M399	M01, M399	M01 DIN	M01, M399	M01	M01 DIN	M16, M46	M16, M46	M16, M46	M16, M46	M16, M46	M16, M46

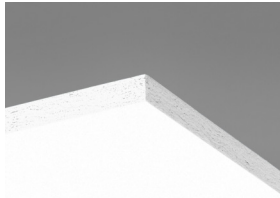

Focus A tile

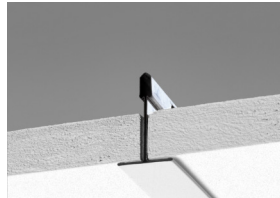

Section of Focus A system with Connect T24

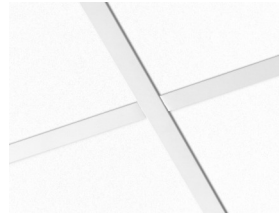

Focus A system



Acoustic

Sound Absorption:

Test results according to EN ISO 354. Classification according to EN ISO 11654, and the single value ratings for Noise Reduction Coefficient, NRC and Sound Absorption Average, SAA according to ASTM C 423.

α_p , Practical sound absorption coefficient

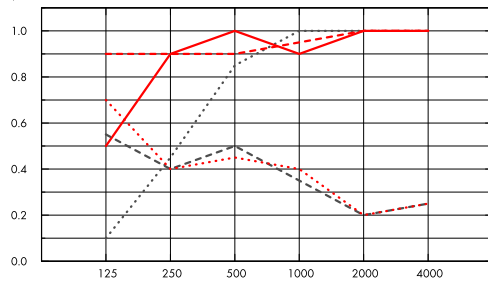

- Focus A 20 mm, 50 mm o.d.s.
- Focus A 20 mm, 200 mm o.d.s.
- - - Focus A 20 mm + Extra Bass 50 mm, 200 mm o.d.s.
- Focus A gamma 20 mm, 200 mm o.d.s.
- Focus A gamma 20 mm + Extra Bass 50 mm, 200 mm o.d.s.

	THK mm	o.d.s. mm	α_p , Practical sound absorption coefficient						α_w	Sound absorption class
			125 Hz	250 Hz	500 Hz	1000 Hz	2000 Hz	4000 Hz		
-	20	50	0.10	0.45	0.85	1.00	1.00	1.00	0.75	C
-	20	200	0.50	0.90	1.00	0.90	1.00	1.00	1.00	A
+ Extra Bass,	70	200	0.90	0.90	0.90	0.95	1.00	1.00	0.95	A
gamma	20	200	0.55	0.40	0.50	0.35	0.20	0.25	0.30	D
gamma+ Extra Bass	70	200	0.70	0.40	0.45	0.40	0.20	0.25	0.30	D

	THK mm	o.d.s. mm	NRC	SAA
-	20	50	0.85	0.83
+ Extra Bass,	70	200	0.93	0.93
gamma	20	200	0.35	0.36
gamma+ Extra Bass	70	200	0.35	0.37
-	20	400	0.85	0.88

THK mm	AC(1.5) Articulation Class, ASTM E1111, ASTM E1110	D_{nfw} Weighted normalized flanking level difference, ISO 10848-2	CAC dB Ceiling Attenuation Class, ASTM 1414, ASTM E413
20	190	20	21



Indoor Air Quality

Certificate / Label	Standard	Plant
Eurofins Indoor Air Comfort®	IAC	IAC Gold
French VOC	A	A+
Finnish M1	•	•



Environmental Footprint

Kg CO ₂ equiv/m ²	
Focus A	2,6 (Focus family EPD in conformity with ISO 14025 / EN 15804)
Focus A/Plant	1,81 (Focus A/Plant EPD in conformity with ISO 14025 / EN 15804)



Circularity

Minimum post-consumer recycled content	51%
Recyclability	Fully recyclable



Fire safety

Country	Standard	Class
Europe	EN 13501-1	A2-s1,d0

The glass wool core of the tiles is tested and classified as non-combustible according to EN ISO 1182.



Humidity Resistance

Product		According to EN 13964:2014
Standard	Class C, RH 95% and 30°C	
Plant	Class A, RH 70% and 25°C	



Visual appearance

White Frost, nearest NCS colour sample S 0500-N, 85% light reflectance. Gloss < 1.



Cleanability

Daily dusting and vacuum cleaning. Weekly wet wiping.



Accessibility

The tiles are easily demountable. Minimum demounting depth according to installation diagrams.



Installation

Installed according to installation diagrams, installation guides and drawing aid. For information regarding minimum overall depth of system see quantity specification.



System weight

The weight of the system (including suspension grid) should be approximately 3 kg/m².



Mechanical properties

See table about Max live load and Min load bearing capacity and Functional demands, Mechanical properties at www.ecophon.com.



CE

Ecophon ceiling systems are CE marked according to the European harmonized standard EN 13964:2014. CE marked construction products are covered by a Declaration of Performance (DOP) which enables customers and users to easily compare performance of products available on the European market.

INSTALLATION DIAGRAM (M01) FOR ECOPHON FOCUS A

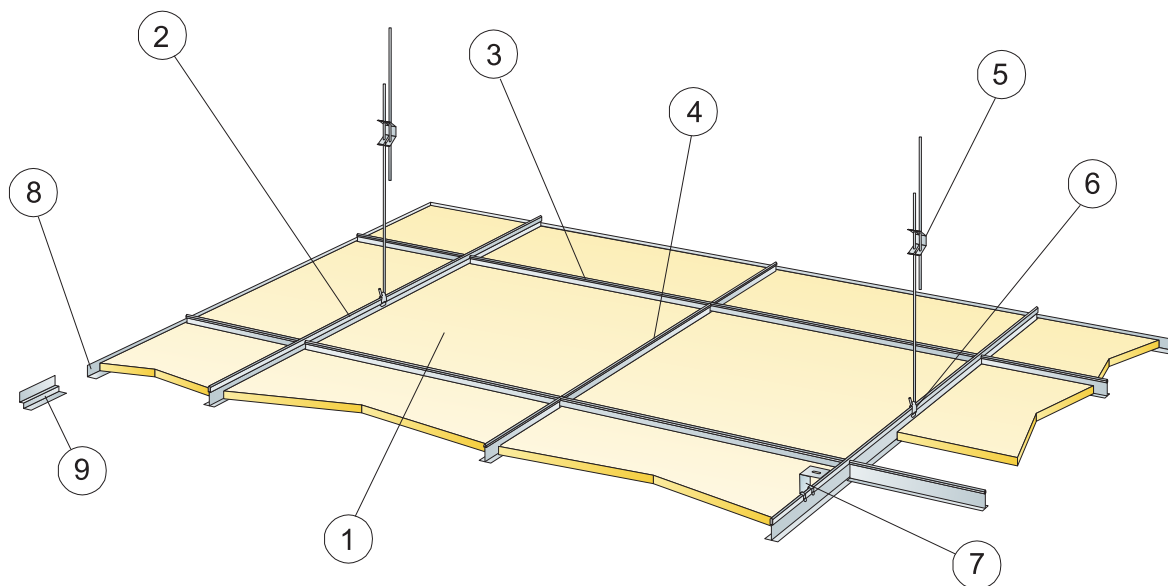

© Ecophon Group

QUANTITY SPECIFICATION (EXCL. WASTAGE)

	Size, mm		
	600x600	1200x600	1200x1200
1 Focus A	2,8/m ²	1,4/m ²	0,7/m ²
2 Connect T24 or T15 Main runner, installed at 1200 mm centres (max. distance from wall 600 mm, can be extended up to 1200 mm if no live load between Main runner and wall).	0,9m/m ²	0,9m/m ²	0,9m/m ²
3 Connect T24 or T15 Cross tee, L=1200 mm, installed at 600 mm centres	1,7m/m ²	1,7m/m ²	0,9m/m ²
4 Connect T24 or T15 Cross tee, L=600 mm	0,9m/m ²	-	-
5 Connect Adjustable hanger, installed at 1200 mm centres (max. distance from wall 600 mm)	0,7/m ²	0,7/m ²	0,7/m ²
6 Connect Hanger Clip (not to be used in swimming hall environments)	0,7/m ²	0,7/m ²	0,7/m ²
7 For direct installation: Connect Direct Bracket, installed at 1200 mm centres	0,7/m ²	0,7/m ²	0,7/m ²
8 Connect Angle trim, fixed at 300 mm centres	as required	as required	as required
9 Connect Shadow-line trim, fixed at 300 mm centres	as required	as required	as required
Δ Min. overall depth of system, with adjustable hanger: 100 mm, with direct bracket: 50 mm	-	-	-
δ Min. demounting depth: 120 mm (130 mm with 1200x1200)	-	-	-
For luminaire integration in panels use Connect Bridging	-	-	-
When using panels in format 1200x1200 mm and XL-format in combination with T15 grid, secure grid with wall brackets	-	-	-

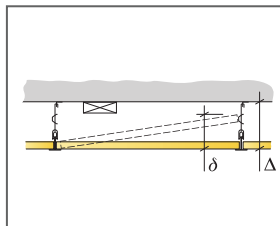

See Quantity specification

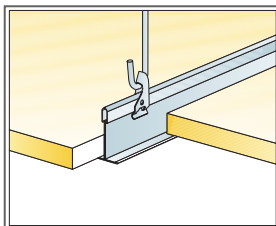

Suspension with adjustable hanger and clip

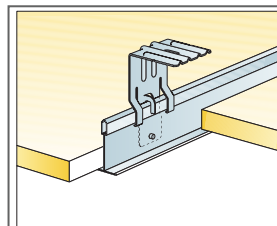

Suspension with direct bracket

Size, mm	Max live load (N)	Min load bearing capacity (N)
600x600	50	160
1200x600	50	160
1200x1200	50	160

Live load/load bearing capacity

INSTALLATION DIAGRAM (M01) FOR ECOPHON FOCUS A

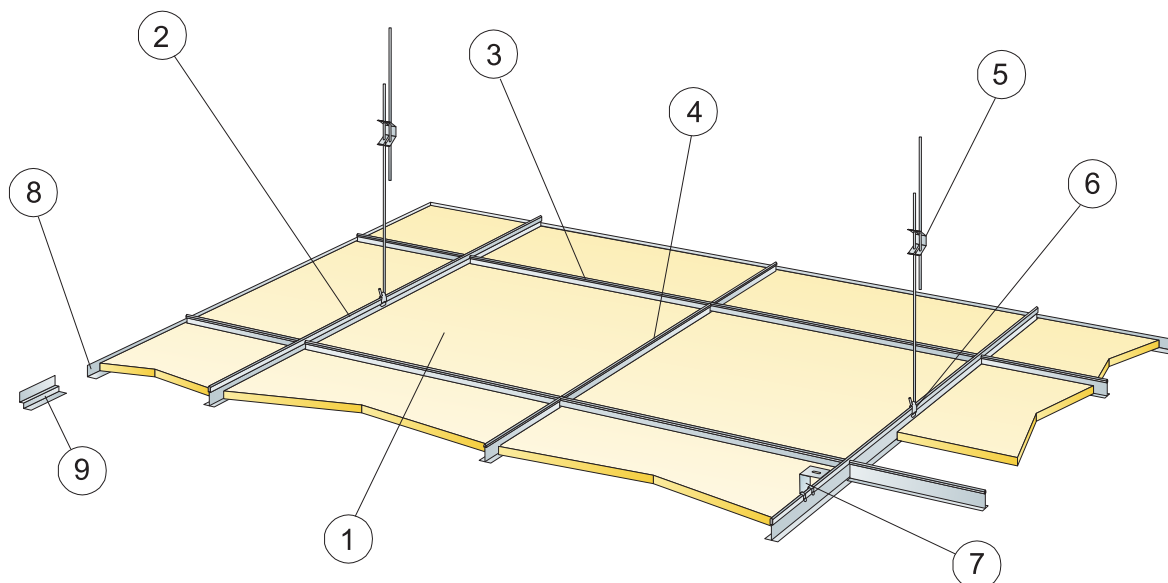

© Ecophon Group

QUANTITY SPECIFICATION (EXCL. WASTAGE)

	Size, mm	
	625x625	1250x625
1 Focus A	2,6/m ²	-
2 Connect T24 Main Runner, installed at 1250 mm centres for DIN (only white profiles)	0,8m/m ²	0,8m/m ²
3 Connect T24 or T15 Cross Tee, L=1250 mm, installed at 625 mm centres	1,6m/m ²	1,6m/m ²
4 Connect T24 or T15 Cross Tee, L=625 mm	0,8m/m ²	-
5 Connect Adjustable Hanger, installed at 1250 mm centres (max. distance from wall 600 mm)	0,7/m ²	0,7/m ²
6 Connect Hanger Clip (not to be used in swimming hall environments)	0,7/m ²	0,7/m ²
7 For direct installation: Connect Direct Bracket, installed at 1250 mm centres	0,7/m ²	0,7/m ²
8 Connect Angle trim, fixed at 300 mm centres	as required	as required
9 Connect Shadow-line trim, fixed at 300 mm centres	as required	as required
Δ Min. overall depth of system, with adjustable hanger: 100 mm, with direct bracket: 50 mm	-	-
δ Min. demounting depth: 120 mm	-	-
For luminaire integration in panels use Connect Bridging	-	-

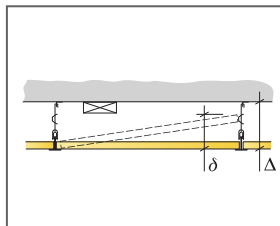

See Quantity specification

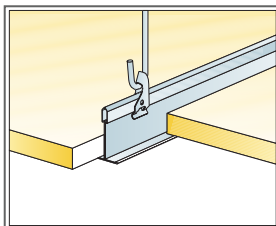

Suspension with adjustable hanger and clip

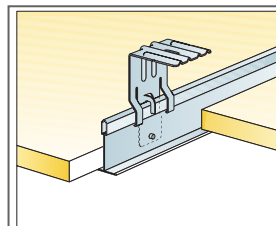

Suspension with direct bracket

Size, mm	Max live load (N)	Min load bearing capacity (N)
625x625	40	160

Live load/load bearing capacity

INSTALLATION DIAGRAM (M16) FOR ECOPHON FOCUS A XL IN CORRIDORS

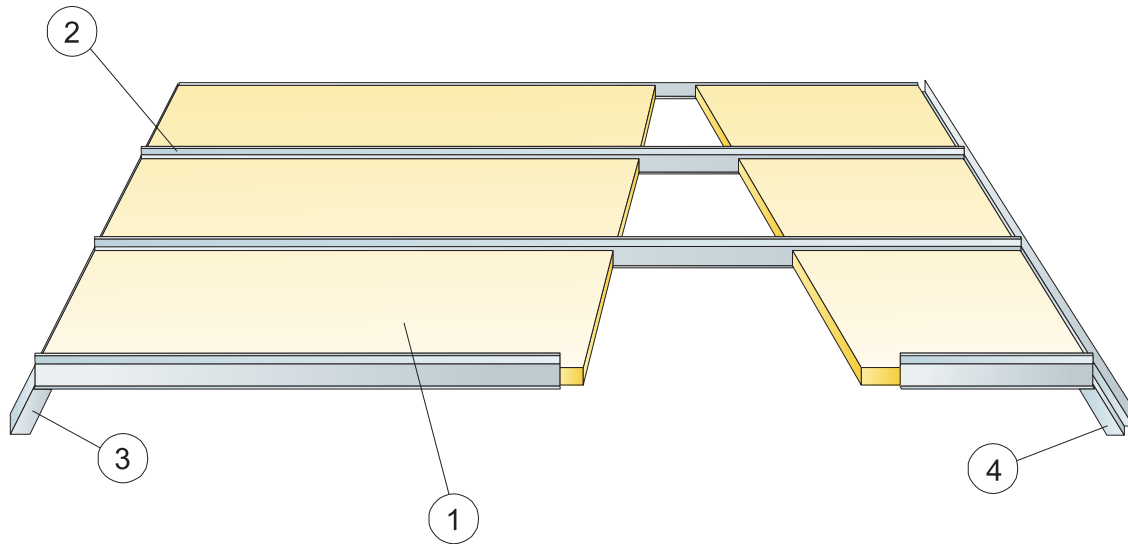

© Ecophon Group

QUANTITY SPECIFICATION (EXCL. WASTAGE)

	Size, mm			
	1600x600	1800x600	2000x600	2400x600
1 Focus A	1,05/m ²	0,95/m ²	0,85/m ²	0,7/m ²
2 Connect T24 Corridor profile, installed at 600 mm centres	1,05/m ²	0,95/m ²	0,85/m ²	0,7/m ²
3 Connect Angle trim, fixed at 200 mm centres	as required	as required	as required	as required
4 Connect Shadow-line trim, fixed at 200 mm centres	as required	as required	as required	as required
Δ Min. overall depth of system: 40 mm	-	-	-	-
δ Min. demounting depth: 65 mm	-	-	-	-

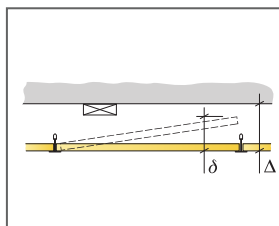

See Quantity specification

INSTALLATION DIAGRAM (M46) FOR ECOPHON FOCUS A XL

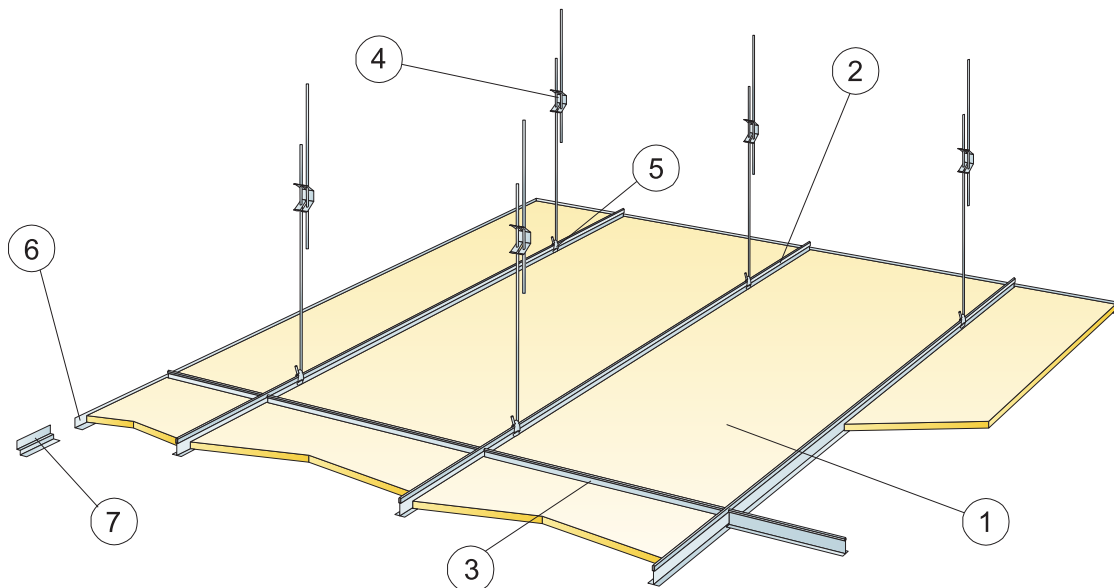

© Ecophon Group

QUANTITY SPECIFICATION (EXCL. WASTAGE)

	Size, mm			
	1600x600	1800x600	2000x600	2400x600
1 Focus A	1,05/m ²	0,95/m ²	0,85/m ²	0,7/m ²
2 Connect T24 Main runner, installed at 600 mm centres	1,7m/m ²	1,7m/m ²	1,7m/m ²	1,7m/m ²
3 Connect T24 Cross tee, L=600 mm	0,65m/m ²	0,6m/m ²	0,5m/m ²	0,45m/m ²
4 Connect Adjustable hanger, installed at 1500 mm centres (max. distance from wall 450 mm)	1,1/m ²	1,1/m ²	1,1/m ²	1,1/m ²
5 Connect Hanger clip	1,1/m ²	1,1/m ²	1,1/m ²	1,1/m ²
6 Connect Angle trim, fixed at 300 mm centres	as required	as required	as required	as required
7 Connect Shadow-line trim, fixed at 300 mm centres	as required	as required	as required	as required
Δ Min. overall depth of system: 100 mm	-	-	-	-
δ Min. demounting depth: 100 mm	-	-	-	-

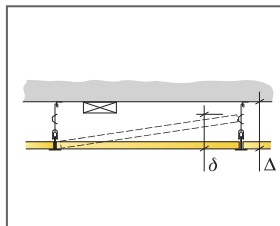

See Quantity specification

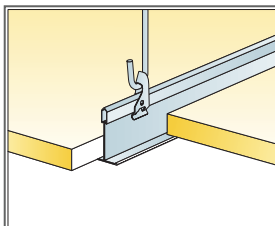

Suspension with adjustable hanger and clip

Size, mm	Max live load (N)	Min load bearing capacity (N)
1600x600	50	160
1800x600	50	160
2000x600	50	160
2400x600	50	160

Live load/load bearing capacity

INSTALLATION DIAGRAM (M399) FOR ECOPHON FOCUS A

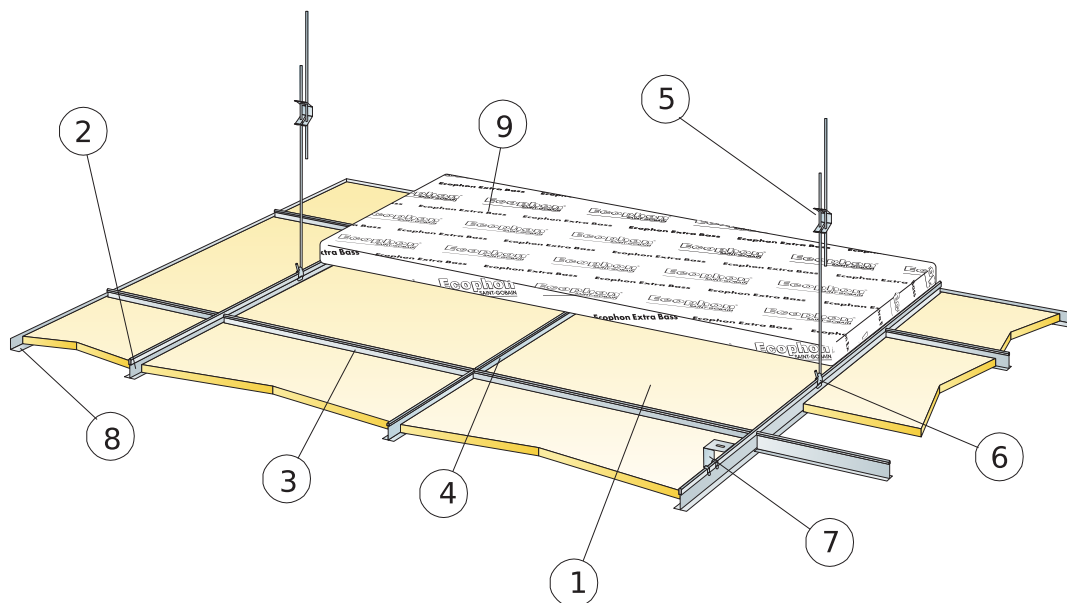

© Ecophon Group

QUANTITY SPECIFICATION (EXCL. WASTAGE)

	Size, mm	
	600x600	1200x600
1 Focus A	2,8/m ²	1,4/m ²
2 Connect T24 Main runner black, installed at 1200 mm centres (max. distance from wall 600 mm, can be extended up to 1200 mm if no live load between Main runner and wall).	0,9m/m ²	0,9m/m ²
3 Connect T24 Cross tee black, L=1200 mm, installed at 600 mm centres	1,7m/m ²	1,7m/m ²
4 Connect T24 Cross tee black, L=600 mm	0,9m/m ²	-
5 Connect Adjustable Hanger, installed at 1200 mm centres (max. distance from wall 600 mm)	0,7/m ²	0,7/m ²
6 Connect Hanger Clip (not to be used in swimming hall environments)	0,7/m ²	0,7/m ²
7 For direct installation: Connect Direct Bracket, installed at 1200 mm centres	0,7/m ²	0,7/m ²
8 Connect Angle trim black, (fixed at 300 mm centres)	as required	as required
9 Extra Bass (1200x600x50 mm)	0,7/m ²	0,7/m ²
Δ Min. overall depth of system: Focus A: 50 mm (Direct bracket). Focus A/with Extra bass: 100 mm.	-	-
δ Min. demounting depth: Focus A: 130 mm, Focus A/with Extra bass: 170 mm	-	-

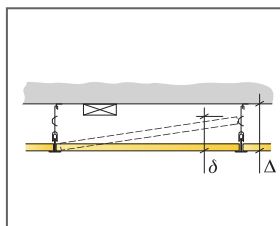

See Quantity specification

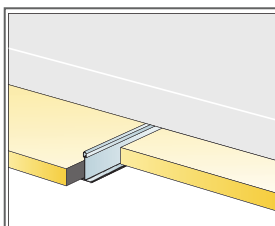

Installation with Extra Bass

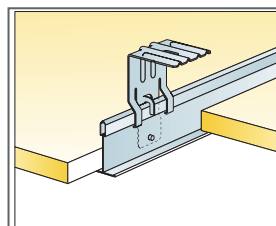

Suspension with adjustable hanger and clip

Size, mm	Max live load (N)	Min load bearing capacity (N)
600x600	50	160
1200x600	50	160

Live load/load bearing capacity

Ecophon Focus™ B

Ecophon Focus™ B are bonded edge-to-edge directly to the soffit surface, creating a ceiling with a smooth appearance. The bevelled edge creates a narrow groove between each tile. For applications where the minimum possible overall depth of system is required.



SYSTEM RANGE

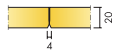

Size, mm	600x600	1200x600
Direct	•	•
Thickness (THK)	20	20
Inst. Diagr.	M03	M03

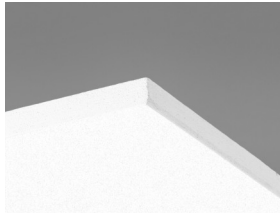

Focus B tile

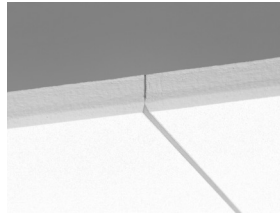

Section of Focus B system

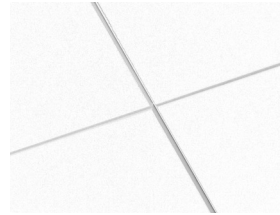

Focus B system



Acoustic

Sound Absorption:

Test results according to EN ISO 354. Classification according to EN ISO 11654, and the single value ratings for Noise Reduction Coefficient, NRC and Sound Absorption Average, SAA according to ASTM C 423.

α_p , Practical sound absorption coefficient

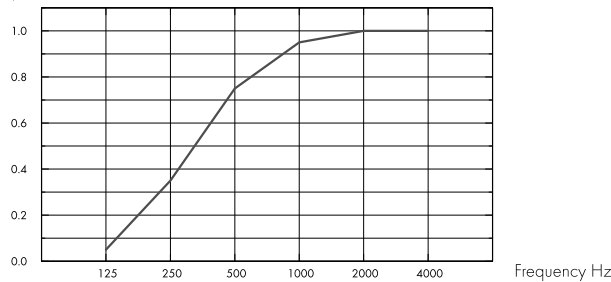

– Focus B 20 mm, 20 mm o.d.s.

THK mm	o.d.s. mm	α_p , Practical sound absorption coefficient						α_w	Sound absorption class
		125 Hz	250 Hz	500 Hz	1000 Hz	2000 Hz	4000 Hz		
20	20	0.05	0.35	0.75	0.95	1.00	1.00	0.65	C

THK mm	o.d.s. mm	NRC	SAA
20	20	0.80	0.78



Indoor Air Quality

Certificate / Label	Standard	Plant
Eurofins Indoor Air Comfort®	IAC	IAC Gold
French VOC	A	A+
Finnish M1	•	•



Environmental Footprint

	Kg CO ₂ equiv/m ²
Focus B	4,10 (Focus family EPD in conformity with ISO 14025 / EN 15804)
Focus B/Plant	2,87 (Focus B/Plant EPD in conformity with ISO 14025 / EN 15804)



Circularity

Minimum post-consumer recycled content	56%
Recyclability	Fully recyclable



Fire safety

Country	Standard	Class
Europe	EN 13501-1	A2-s1,d0

The glass wool core of the tiles is tested and classified as non-combustible according to EN ISO 1182.



Humidity Resistance

Product	
Standard	Class C, RH 95% and 30°C
Plant	Class A, RH 70% and 25°C

According to EN 13964:2014



Visual appearance

White Frost, nearest NCS colour sample S 0500-N, 85% light reflectance. Gloss < 1.



Cleanability

Daily dusting and vacuum cleaning. Weekly wet wiping.



Accessibility

The tiles are not demountable.



Installation

Installed according to installation diagrams, installation guides and drawing aid. For information regarding minimum overall depth of system see quantity specification. Rendered surfaces must have sufficient strength to be able to carry the load imposed by the tiles. If doubts, test gluing should be carried out. The surface should always be dry and clean. For best result the surface should be even.



System weight

The weight of the system should be approximately 2,5 kg/m²



Mechanical properties

Additional live load has to be fixed to the soffit.



CE

Ecophon ceiling systems are CE marked according to the European harmonized standard EN 13964:2014. CE marked construction products are covered by a Declaration of Performance (DOP) which enables customers and users to easily compare performance of products available on the European market.

INSTALLATION DIAGRAM (M03) FOR ECOPHON FOCUS B, USING CONNECT ABSORBER GLUE

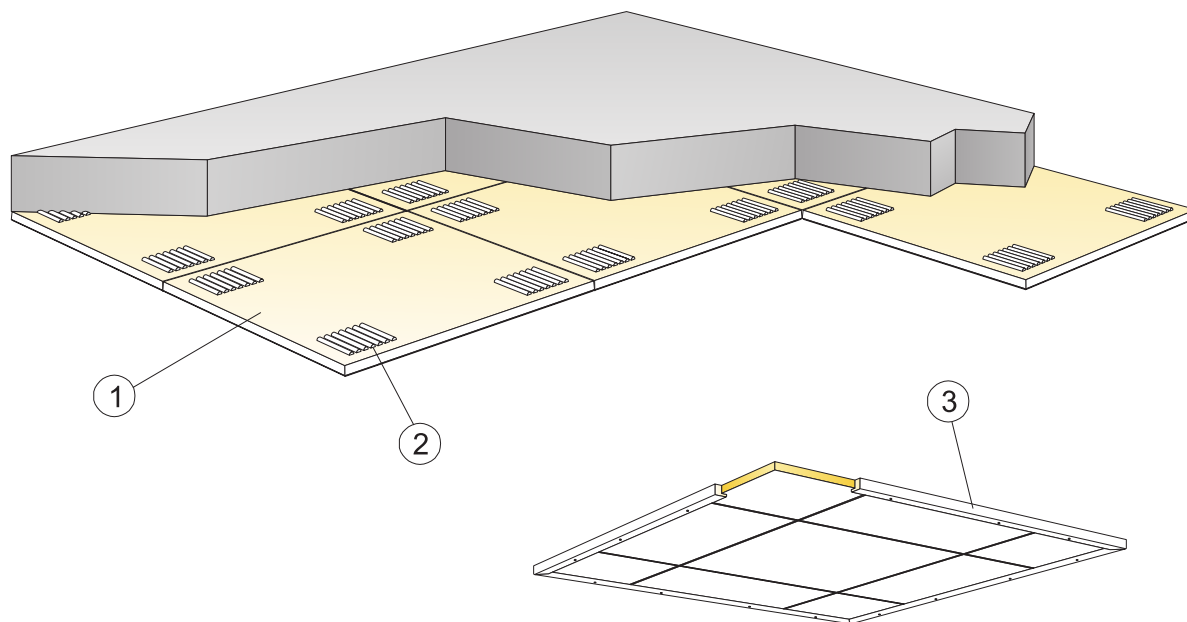

© Ecophon Group

QUANTITY SPECIFICATION (EXCL. WASTAGE)

	Size, mm	
	600x600	1200x600
1 Focus B	2,8/m ²	-
2 Connect Absorber glue [0,25 l/m ² - 0,4 l/m ² depending on installation conditions] Use Connect Notched spatula to apply the glue.	as required	as required
3 When installing floating ceilings: Connect Wood trim, L=2500, fixed at 500 mm centres	as required	as required
Δ Min. overall depth of system: 23 mm	-	-
δ Min. demounting depth: The system is not demountable	-	-
Visible edges should be painted	-	-

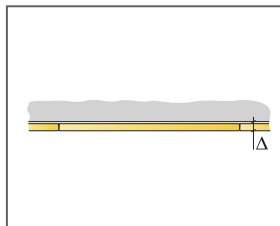

See Quantity specification

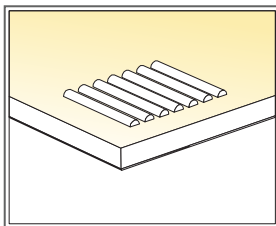

Application of glue

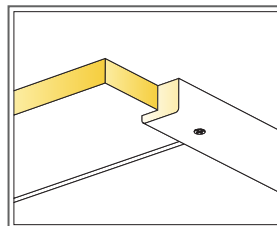

Wood trim for floating installation

Size, mm	Max live load (N)	Min load bearing capacity (N)
1200x600		

Live load/load bearing capacity

Ecophon Focus™ Ds

Ecophon Focus™ Ds has a concealed grid and symmetrical bevelled edge with an even appearance. Increases assembly ease and integration of light fittings and ventilation. For applications where a suspended ceiling with a concealed grid is required, but individual tiles must be easily demountable.



Lunds Tingstift, Sweden

SYSTEM RANGE

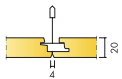

Size, mm	600x600	625x625	1200x600	1200x1200	XL 1600x600	XL 1800x600	XL 2000x600	XL 2400x600
T24	•	•	•	•	•	•	•	•
Thickness (THK)	20	20	20	20	20	20	20	20
Inst. Diag.	M206, M208, M394, M400	M206DIN, M394, M400	M206, M208, M394, M400	M207	M206, M208, M238	M206, M208, M238	M206, M208, M238	M206, M208, M238

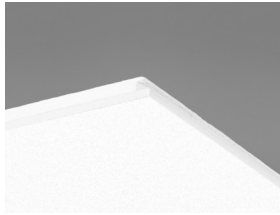

Focus Ds tile

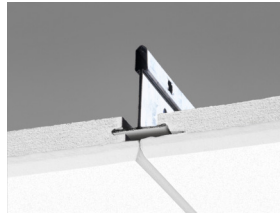

Section of Focus Ds system with Connect T24 Main runner HD

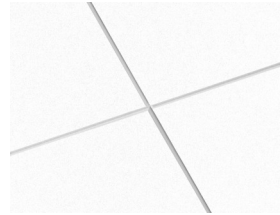

Focus Ds system



The individual tiles are easily demountable



Acoustic

Sound Absorption:

Test results according to EN ISO 354. Classification according to EN ISO 11654, and the single value ratings for Noise Reduction Coefficient, NRC and Sound Absorption Average, SAA according to ASTM C 423.

α_p , Practical sound absorption coefficient

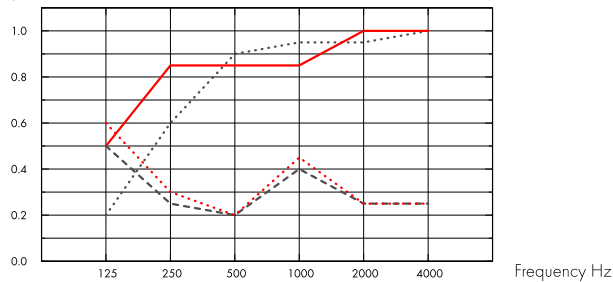

- Focus Ds 20 mm, 65 mm o.d.s.
- Focus Ds 20 mm, 200 mm o.d.s.
- - - Focus Ds gamma 20 mm, 200 mm o.d.s.
- · - · Focus Ds gamma 20 mm + Extra Bass 50 mm, 200 mm o.d.s.

	THK mm	o.d.s. mm	α_p , Practical sound absorption coefficient						α_w	Sound absorption class
			125 Hz	250 Hz	500 Hz	1000 Hz	2000 Hz	4000 Hz		
-	20	65	0.20	0.60	0.90	0.95	0.95	1.00	0.90	A
-	20	200	0.50	0.85	0.85	0.85	1.00	1.00	0.90	A
gamma	20	200	0.50	0.25	0.20	0.40	0.25	0.25	0.25	E
gamma+ Extra Bass	70	200	0.60	0.30	0.20	0.45	0.25	0.25	0.25	E

	THK mm	o.d.s. mm	NRC	SAA
-	20	65	0.90	0.89
gamma	20	200	0.30	0.28
gamma+ Extra Bass	70	200	0.30	0.29
-	20	400	0.80	0.82

THK mm	AC(1.5) Articulation Class, ASTM E1111, ASTM E1110	D_{nfw} Weighted normalized flanking level difference, ISO 10848-2	CAC dB Ceiling Attenuation Class, ASTM 1414, ASTM E413
20	180	24	25



Indoor Air Quality

Certificate / Label	Standard	Plant
Eurofins Indoor Air Comfort®	IAC	IAC Gold
French VOC	A	A+
Finnish M1	•	•





Environmental Footprint

Kg CO ₂ equiv/m ²	
Focus Ds	4,6 (Focus family EPD in conformity with ISO 14025 / EN 15804)
Focus Ds/Plant	2,76 (Focus Ds/Plant EPD in conformity with ISO 14025 / EN 15804)



Circularity

Minimum post-consumer recycled content	57%
Recyclability	Fully recyclable



Fire safety

Country	Standard	Class
Europe	EN 13501-1	A2-s1,d0

The glass wool core of the tiles is tested and classified as non-combustible according to EN ISO 1182.



Humidity Resistance

Product		According to EN 13964:2014
Standard	Class C, RH 95% and 30°C	
Plant	Class A, RH 70% and 25°C	



Visual appearance

White Frost, nearest NCS colour sample S 0500-N, 85% light reflectance. Gloss < 1.



Cleanability

Daily dusting and vacuum cleaning. Weekly wet wiping.



Accessibility

The tiles in size 600x600 and 1200x600 are easily demountable. The tiles in size 1200x1200 and XL sizes are demountable. Minimum demounting depth according to installation diagrams.



Installation

Installed according to installation diagrams, installation guides and drawing aid. For information regarding minimum overall depth of system see quantity specification. The systems are not recommended for small rooms (approximately 2x2 m²). Ceilings with a large amount of integrations require careful planning, design and installation.



System weight

The weight of the system (including suspension grid) should be approximately 3-4 kg/m².



Mechanical properties

See table about Max live load and Min load bearing capacity and Functional demands, Mechanical properties at www.ecophon.com.



CE

Ecophon ceiling systems are CE marked according to the European harmonized standard EN 13964:2014. CE marked construction products are covered by a Declaration of Performance (DOP) which enables customers and users to easily compare performance of products available on the European market.

INSTALLATION DIAGRAM (M206) FOR ECOPHON FOCUS DS 600X600, 1200X600 MM AND ECOPHON FOCUS DS XL. SUSPENDED INSTALLATION

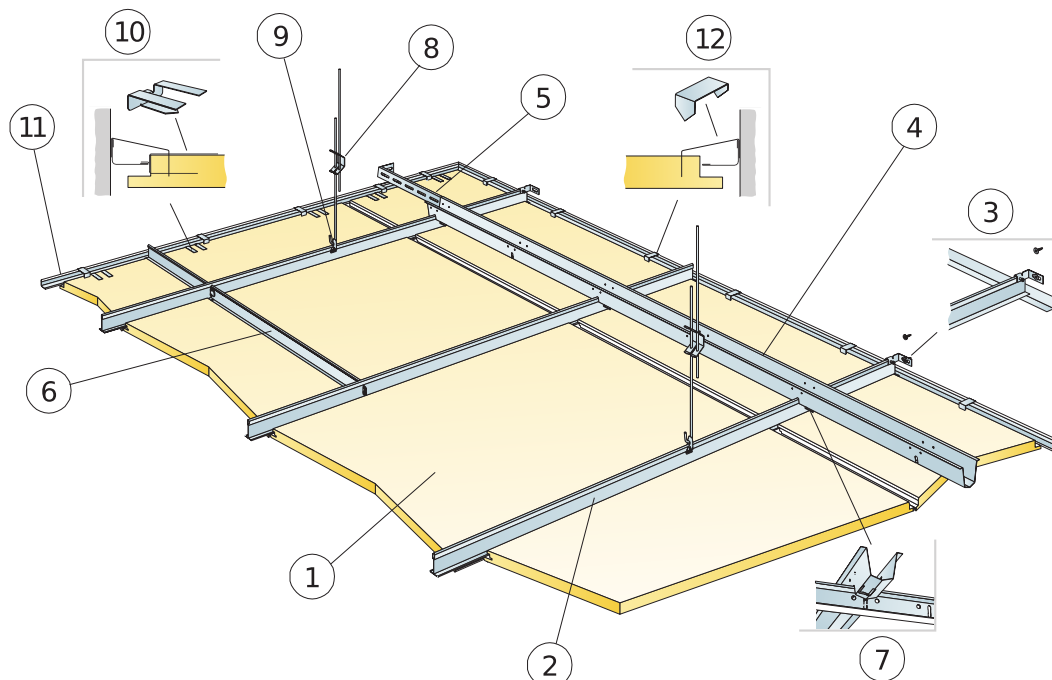

© Ecophon Group

QUANTITY SPECIFICATION [EXCL. WASTAGE]

	Size, mm					
	600x600	1200x600	1600x600	1800x600	2000x600	2400x600
1 Focus Ds	2,8/m ²	1,4/m ²	1,05/m ²	0,95/m ²	0,85/m ²	0,7/m ²
2 Connect T24 Main Runner HD, installed at 600 mm centres	1,7m/m ²	1,7m/m ²	1,7m/m ²	1,7m/m ²	1,7m/m ²	1,7m/m ²
3 Connect Wall Bracket for T-profiles	1/suspended row of Main runner					
4 Connect Space Bar, installed at 1500 mm centres (max. distance from wall 300 mm)	0,7m/m ²	0,7m/m ²	0,7m/m ²	0,7m/m ²	0,7m/m ²	0,7m/m ²
5 Connect Wall Bracket, L=700 mm, for Connect Space Bar	1/row of Space bar					
6 Connect T24 Cross Tee, L=600 mm	2/row of Main runner					
7 Connect Space Bar Winch, installed one per joint Connect Main Runner/Connect Space Bar	1,4/m ²	1,4/m ²	1,4/m ²	1,4/m ²	1,4/m ²	1,4/m ²
8 Connect Adjustable Hanger, installed at 1200 mm centres (max. distance from wall 600 mm)	0,7/m ²	0,7/m ²	0,7/m ²	0,7/m ²	0,7/m ²	0,7/m ²
9 Connect Hanger Clip (not to be used in swimming hall environments)	0,7/m ²	0,7/m ²	0,7/m ²	0,7/m ²	0,7/m ²	0,7/m ²
10 Connect Support clip Dg20	1pc/300-400 mm on every cut perimeter tile with only 1 supporting edge					
11 Connect Angle trim 15/22, fixed at 300 mm centres	as required	as required	as required	as required	as required	as required
12 Connect Perimeter tile clip	1/300-400mm on any cut edge					
Δ Min. overall depth of system: 115 mm	-	-	-	-	-	-
δ Min. demounting depth: 30 mm	-	-	-	-	-	-
For luminaire integration in panels use Connect Bridging	-	-	-	-	-	-

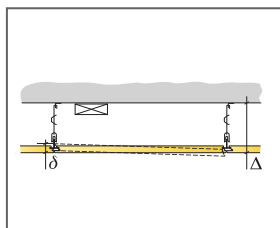

See Quantity Specification

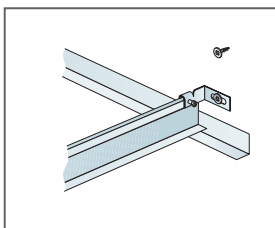

Secured Main runner at wall with Connect Wall bracket

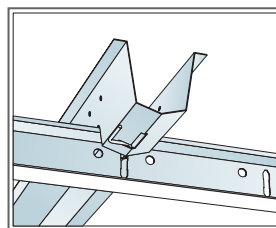

Connection between profiles with space bar winch

Size, mm	Max live load (N)	Min load bearing capacity (N)
600x600	50	160
1200x600	50	160
1600x600	50	160
1800x600	50	160
2000x600	50	160
2400x600	50	160

Live load/load bearing capacity

INSTALLATION DIAGRAM (M206DIN) FOR ECOPHON FOCUS DS 625X625, 1250X625 MM. SUSPENDED INSTALLATION

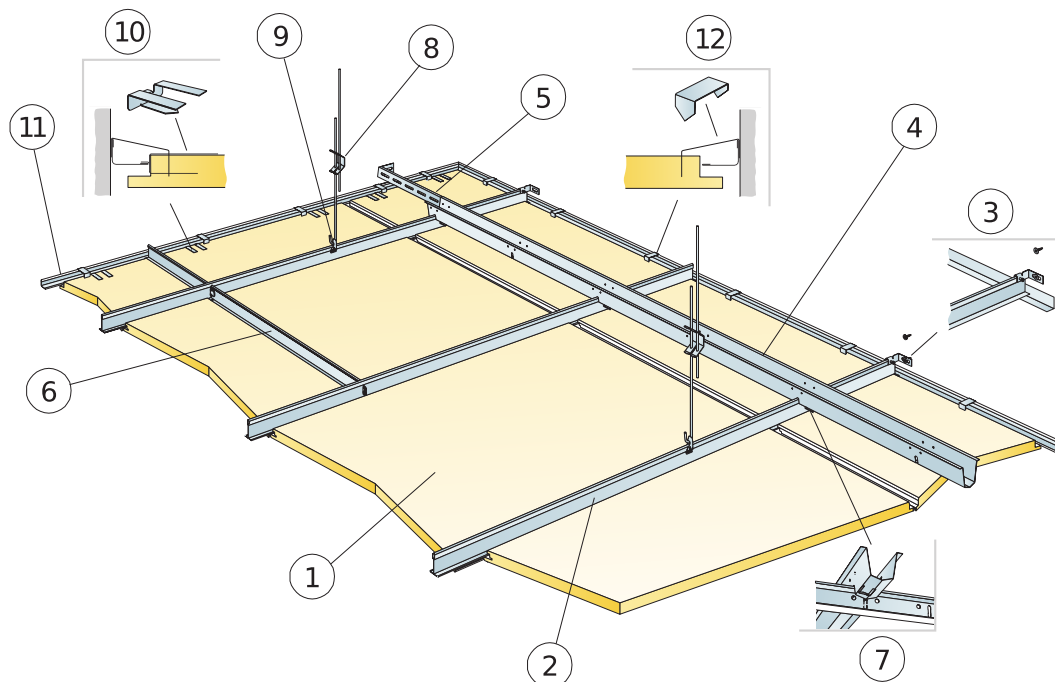

© Ecophon Group

QUANTITY SPECIFICATION (EXCL. WASTAGE)

	Size, mm
625x625	
1 Focus Ds	2,6/m ²
2 Connect T24 Main Runner HD, installed at 625 mm centres	1,6m/m ²
3 Connect Wall Bracket for T-profiles	1/suspended row of Main runner
4 Connect Space Bar Module 625 mm, installed at 1500 mm centres (max. distance from wall 300 mm)	0,7m/m ²
5 Connect Wall Bracket, L=700 mm, for Connect Space Bar	1/row of Space bar
6 Connect T24 or T15 Cross Tee, L=625 mm	2/row of Main runner
7 Connect Space Bar Winch, installed one per joint Connect Main Runner/Connect Space Bar	1,4/m ²
8 Connect Adjustable Hanger, installed at 1250 mm centres (max. distance from wall 600 mm)	0,7/m ²
9 Connect Hanger Clip (not to be used in swimming hall environments)	0,7/m ²
10 Connect Support clip Dg20	1pc/300-400 mm on every cut perimeter tile with only 1 supporting edge
11 Connect Angle trim 15/22, fixed at 300 mm centres	as required
12 Connect Perimeter tile clip	1/300-400mm on any cut edge
Δ Min. overall depth of system: 115 mm	-
δ Min. demounting depth: 30 mm	-
For luminaire integration in panels use Connect Bridging	-

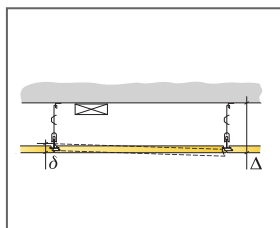

See Quantity Specification

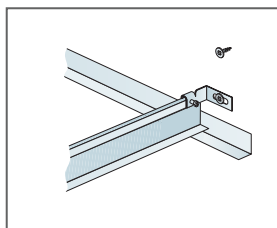

Secured Main runner at wall with Connect Wall bracket

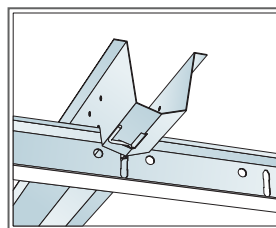

Connection between profiles with space bar winch

Size, mm	Max live load (N)	Min load bearing capacity (N)
625x625	35	175

live load/load bearing capacity

INSTALLATION DIAGRAM (M207) FOR ECOPHON FOCUS DS 1200X1200 MM

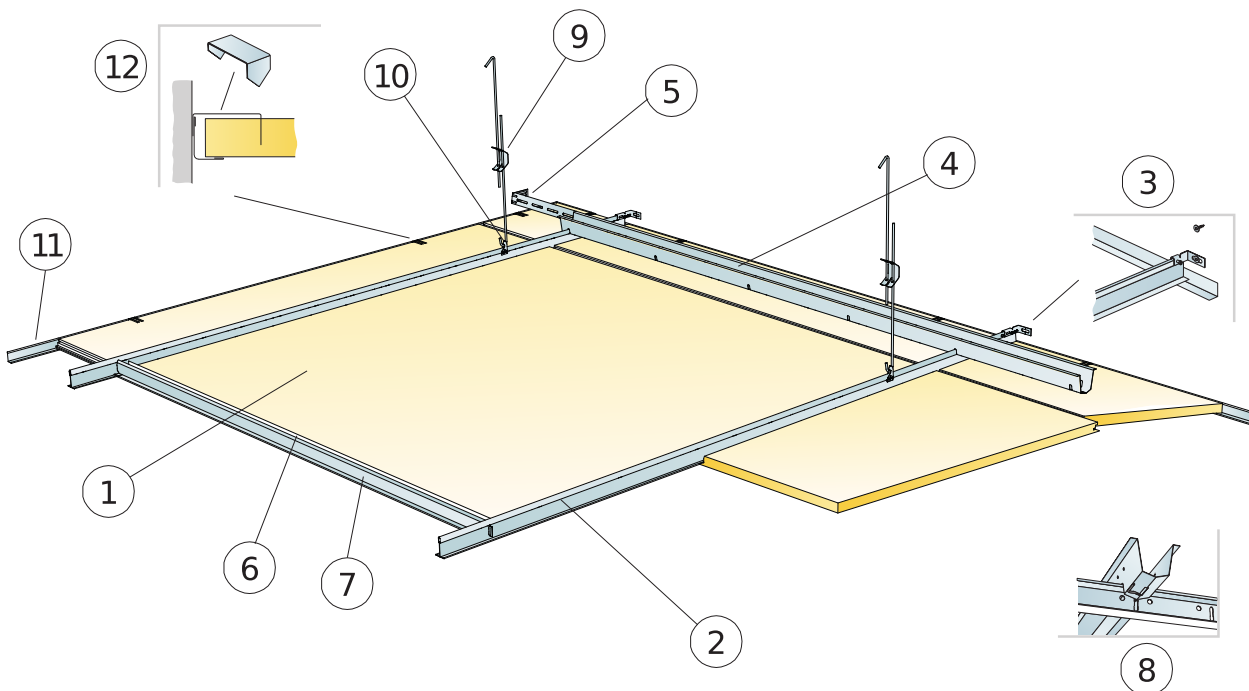

QUANTITY SPECIFICATION (EXCL. WASTAGE)

	Size, mm
	1200x1200
1 Focus Ds	0,7/m ²
2 Connect T24 Main runner HD, installed at 1200 mm centres (max. distance from wall 600 mm, can be extended up to 1200 mm if no live load between Main runner and 0,9m/m ² wall).	0,7m/m ²
3 Connect Wall Bracket for T-profiles	1/suspended row of Main runner
4 Connect Space Bar, installed at 1500 mm centres (max. distance from wall 300 mm)	0,7m/m ²
5 Connect Wall Bracket, L=700 mm, for Connect Space Bar	1/row of Space bar
6 Connect Edge stiffener	1,4/m ²
7 Connect T24 Cross tee, L=1200 mm	2/row of Main runner
8 Connect Space Bar Winch, installed one per joint Connect Main Runner/Connect Space Bar	0,7/m ²
9 Connect Adjustable Hanger, installed at 1200 mm centres (max. distance from wall 600 mm)	0,7/m ²
10 Connect Hanger Clip (not to be used in swimming hall environments)	0,7/m ²
11 Connect Angle trim 15/22, fixed at 300 mm centres	as required
12 Connect Perimeter tile clip	1/300-400mm on any cut edge
Δ Min. overall depth of system: 115 mm	-
δ Min. demounting depth: 50 mm	-
For luminaire integration in panels use Connect Bridging	-

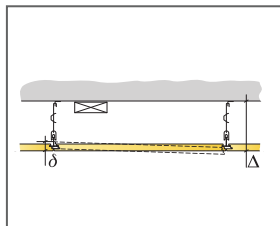

See Quantity specification

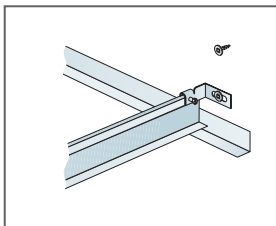

Secured Main runner at wall with Connect Wall bracket

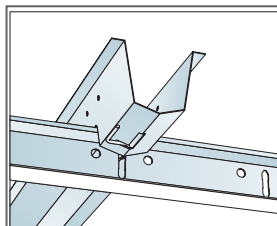

Connection between profiles with space bar winch

Size, mm	Max live load (N)	Min load bearing capacity (N)
1200x1200	50	160

Live load/load bearing capacity

INSTALLATION DIAGRAM (M208) FOR ECOPHON FOCUS DS, DIRECT INSTALLATION

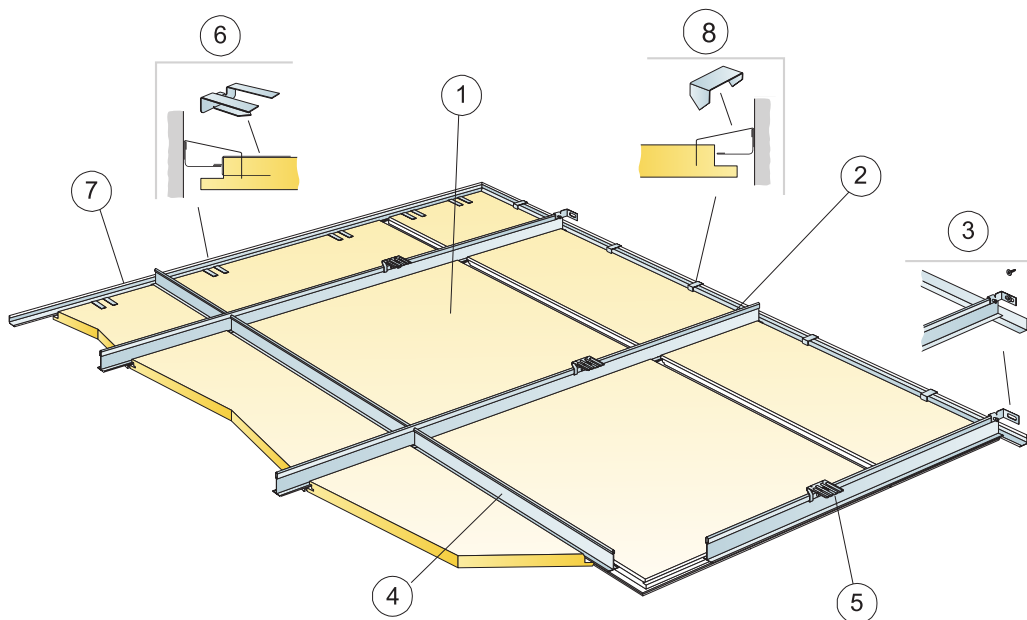

© Ecophon Group

QUANTITY SPECIFICATION (EXCL. WASTAGE)

	Size, mm					
	600x600	1200x600	1600x600	1800x600	2000x600	2400x600
1 Focus Ds	2,8/m ²	1,4/m ²	1,05/m ²	0,95/m ²	0,85/m ²	0,7/m ²
2 Connect T24 Main Runner HD, installed at 600 mm centres	1,7m/m ²	1,7m/m ²	1,7m/m ²	1,7m/m ²	1,7m/m ²	1,7m/m ²
3 Connect Wall Bracket for T-profiles	1/suspended row of Main runner					
4 Connect T24 Cross Tee, L=600	2/row of Main runner					
5 Connect Direct bracket, installed at 1500 mm centres	1,1/m ²	1,1/m ²	1,1/m ²	1,1/m ²	1,1/m ²	1,1/m ²
6 Connect Support clip Dg20	1/300-400mm on any cut edge					
7 Connect Angle trim 15/22, fixed at 300 mm centres	as required	as required	as required	as required	as required	as required
8 Connect Perimeter tile clip can be used if sufficient space is available.	1pc/300-400 mm on every cut perimeter tile with only 1 supporting edge					
Δ Min. overall depth of system: 65 mm	-	-	-	-	-	-
δ Min. demounting depth: 30 mm	-	-	-	-	-	-
For luminaire integration in panels use Connect Bridging	-	-	-	-	-	-

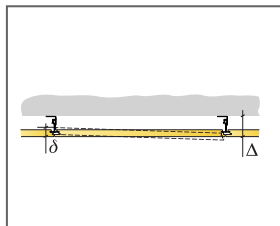

See Quantity specification

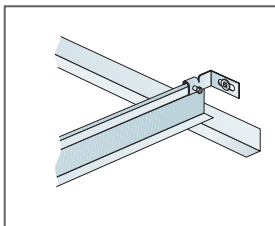

Secured Main runner at wall with Connect Wall bracket

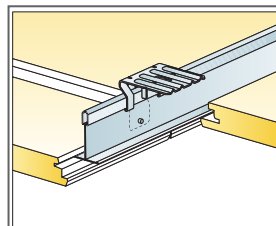

Suspension with direct fix bracket

Size, mm	Max live load (N)	Min load bearing capacity (N)
600x600	50	160
1200x600	50	160
1600x600	50	160
1800x600	50	160
2000x600	50	160
2400x600	50	160

Live load/load bearing capacity

INSTALLATION DIAGRAM (M238) FOR ECOPHON FOCUS DS XL IN CORRIDORS

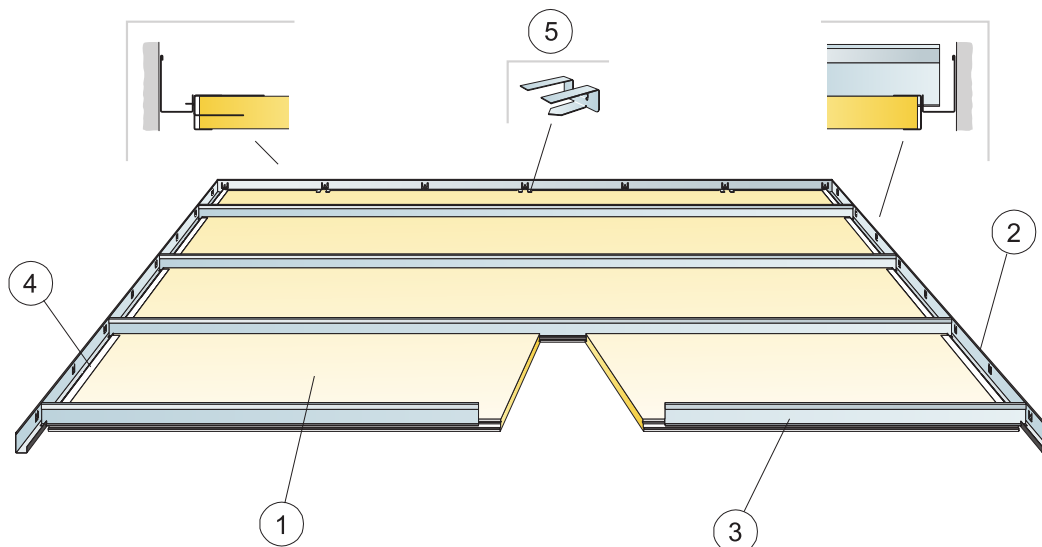

© Ecophon Group

QUANTITY SPECIFICATION (EXCL. WASTAGE)

		Size, mm			
		1600x600	1800x600	2000x600	2400x600
1	Focus Ds XL	1,05/m ²	0,95/m ²	0,85/m ²	0,7/m ²
2	Connect Modular Wall trim	as required	as required	as required	as required
3	Connect T24 Corridor profile	1,05/m ²	0,95/m ²	0,85/m ²	0,7/m ²
4	Connect Cover trim Ds	2/tile plus end tiles			
5	Connect Support clip Dg 20	1 pc/300-400 mm on every cut perimeter tile with only 1 supporting edge			
Δ Min. overall depth of system: 55 mm		-	-	-	-
δ Min. demounting depth: 30 mm		-	-	-	-

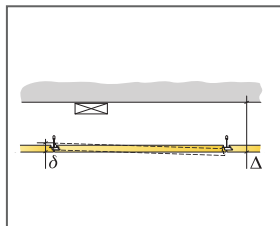

See Quantity specification

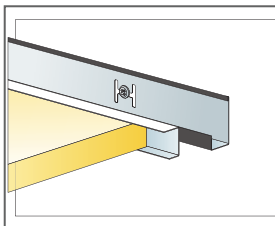

Tile and Connect Cover trim Ds

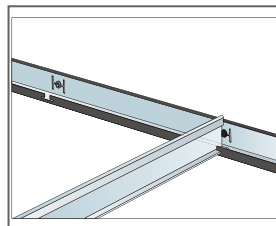

Corridor profile positioned by Modular wall trim

INSTALLATION DIAGRAM (M394) FOR ECOPHON FOCUS DS LEVEL CHANGE

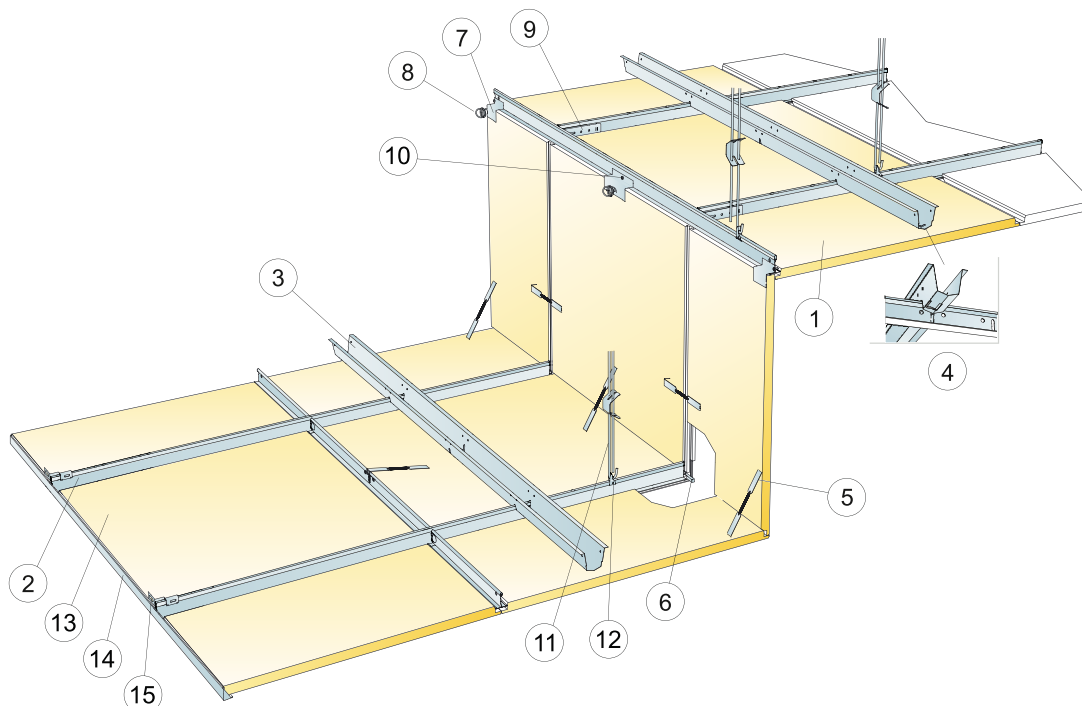

QUANTITY SPECIFICATION (EXCL. WASTAGE)

	Size, mm		
	600x600	625x625	1200x600
1 Focus Ds	2,8/m ²	-	1,4/m ²
2 Connect T24 Main Runner HD, installed at 600 mm centres	1,7m/m ²	1,6m/m ²	1,7m/m ²
3 Connect Space bar, installed at 1500 mm centres (max. distance from Vertical tile 450 mm)	0,7m/m ²	0,7m/m ²	0,7m/m ²
4 Connect Space Bar Winch, installed one per joint Connect Main Runner/Connect Space Bar	1,4/m ²	1,4/m ²	1,4/m ²
5 Connect Hook	3/panel	-	3/panel
6 Connect Distance Ds (included in Level change Ds kit)	1/panel	-	1/panel
7 Connect level clip Ds (included in Level change Ds kit)	1/panel	-	1/panel
8 Connect Spiral anchor	1/panel	-	1/panel
9 Connect L-coupling	1/row of Main runner HD	-	1/row of Main runner HD
10 Connect Installation screw BR	as required	-	as required
11 Connect Adjustable hanger, installed at 1200 mm centres (max. distance from wall 600 mm)	0,7/m ²	0,7/m ²	0,7/m ²
12 Connect Hanger Clip (not to be used in swimming hall environments)	0,7/m ²	0,7/m ²	0,7/m ²
13 Focus Ds Perimeter tile L-300x600	as required	1 as required	as required
14 Connect Wall Bracket for T-profiles	1/suspended row of Main runner		
15 Connect Angle trim 15/22, fixed at 300 mm centres	as required	as required	as required
Δ Min. overall depth of system: $\Delta_1=165$ mm and $\Delta_2=80$ mm from upper level	-	-	-
δ Min. demounting depth: Individual ceiling tiles are non-demountable	-	-	-
Dimension: c=600 mm, h<530 mm	-	-	-

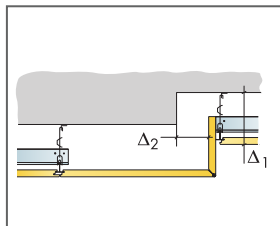

See Quantity specification

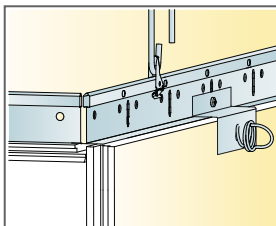

Distance between Focus Lp tiles

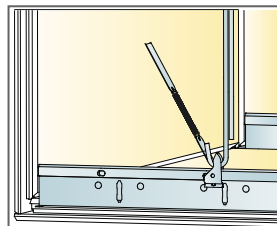

Lower level connection fixed with Hook

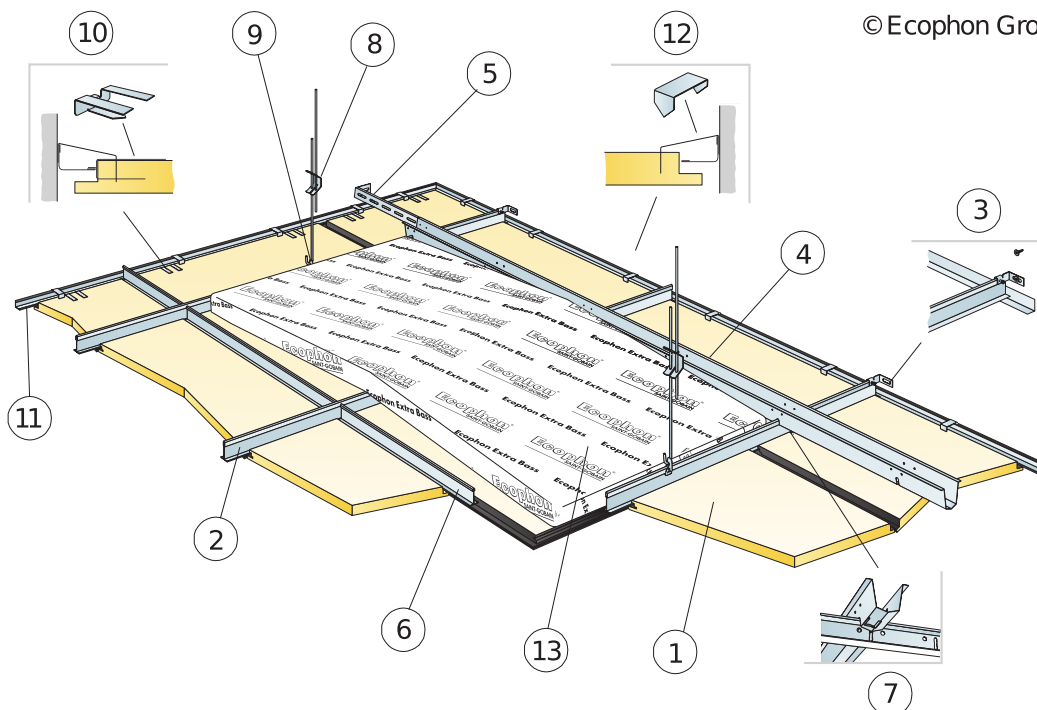

QUANTITY SPECIFICATION (EXCL. WASTAGE)

	Size, mm		
	600x600	625x625	1200x600
1 Focus Ds	2,8/m ²	2,6/m ²	1,4/m ²
2 Connect T24 Main runner HD, installed at 600 mm centres	1,7m/m ²	1,6m/m ²	1,7m/m ²
3 Connect Wall Bracket for T-profiles	1/suspended row of Main runner		
4 Connect Space Bar, installed at 1500 mm centres (max. distance from wall 300 mm)	0,7m/m ²	0,7m/m ²	0,7m/m ²
5 Connect Wall Bracket, L=700 mm, for Connect Space Bar	1/row of Space bar		
6 Connect T24 Cross tee, L=600 mm	2/row of Main runner HD		
7 Connect Space Bar Winch, installed one per joint Connect Main Runner/Connect Space Bar	1,4/m ²	1,4/m ²	1,4/m ²
8 Connect Adjustable Hanger, installed at 1200 mm centres (max. distance from wall 600 mm)	0,7/m ²	0,7/m ²	0,7/m ²
9 Connect Hanger Clip (not to be used in swimming hall environments)	0,7/m ²	0,7/m ²	0,7/m ²
10 Connect Support clip Dg20	1/300-400mm on any cut edge		
11 Connect Angle trim black, (fixed at 300 mm centres)	as required	as required	as required
12 Connect Perimeter tile clip	1/300-400mm on any cut edge		
13 Extra Bass (1200x600x50 mm)	0,7/m ²	0,7/m ²	0,7/m ²
Δ Min. overall depth of system: 115 mm	-	-	-
δ Min. demounting depth: 30 mm	-	-	-

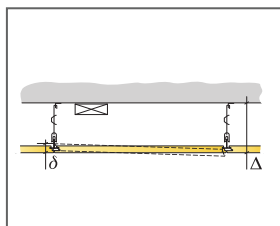

See Quantity specification

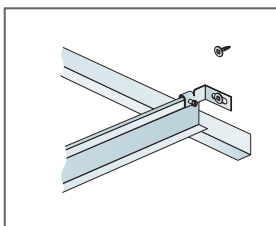

Connection between profiles with split pin

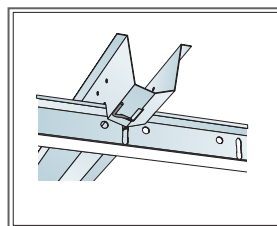

Connection between profiles with space bar winch

Size, mm	Max live load (N)	Min load bearing capacity (N)
600x600	50	160
1200x600	50	160

Live load/load bearing capacity

Ecophon Focus™ Dg

Ecophon Focus™ Dg conceals the supporting tile edges and creates a distinctive floating appearance. Tiles are easily demountable even in areas where there is a very small overall depth of system. For applications where a unique demountable suspended ceiling is required.



Kia Motors, Breda, Netherlands

SYSTEM RANGE

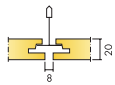

Size, mm	600x600	1200x600	1200x1200	XL 1600x600	XL 1800x600	XL 2000x600	XL 2400x600
T24	•	•	•	•	•	•	•
Thickness (THK)	20	20	25	20	20	20	20
Inst. Diagr.	M202	M202	M203	M204	M204	M204	M204

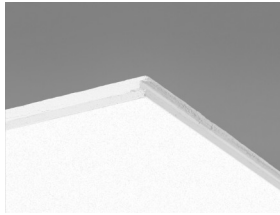

Focus Dg tile

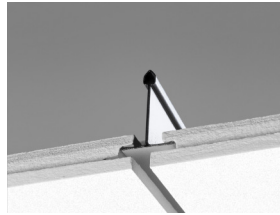

Section of Focus Dg with Connect T24 HD Main runner

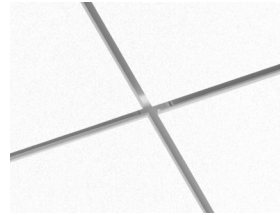

Focus Dg system

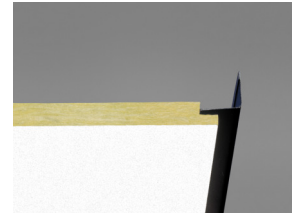

Focus Dg with Connect Angle trim Ultra matt black



Acoustic

Sound Absorption:

Test results according to EN ISO 354. Classification according to EN ISO 11654, and the single value ratings for Noise Reduction Coefficient, NRC and Sound Absorption Average, SAA according to ASTM C 423.

α_p , Practical sound absorption coefficient

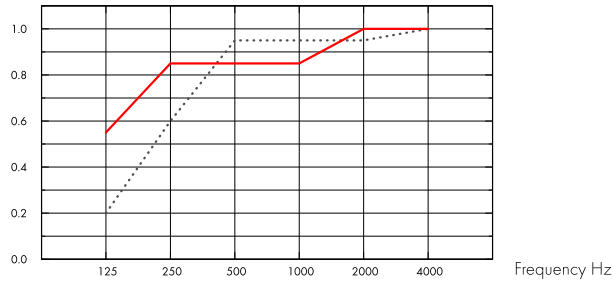

..... Focus Dg 20 mm, 65 mm o.d.s.

— Focus Dg 20 mm, 200 mm o.d.s.

THK mm	o.d.s. mm	α_p , Practical sound absorption coefficient						α_w	Sound absorption class
		125 Hz	250 Hz	500 Hz	1000 Hz	2000 Hz	4000 Hz		
20	65	0.20	0.60	0.95	0.95	0.95	1.00	0.90	A
20	200	0.55	0.85	0.85	0.85	1.00	1.00	0.90	A

THK mm	o.d.s. mm	NRC	SAA
20	65	0.90	0.89
20	400	0.80	0.82

THK mm	AC(1.5)
20	Articulation Class, ASTM E1111, ASTM E1110 180



Indoor Air Quality

Certificate / Label	Standard	Plant
Eurofins Indoor Air Comfort®	IAC	IAC Gold
French VOC	A	A+
Finnish M1	•	•





Environmental Footprint

Kg CO ₂ equiv/m ²	
Focus Dg	4,2 (Focus family EPD in conformity with ISO 14025 / EN 15804)
Focus Dg/Plant	2,76 (Focus Dg/Plant EPD in conformity with ISO 14025 / EN 15804)



Circularity

Minimum post-consumer recycled content	59%
Recyclability	Fully recyclable



Fire safety

Country	Standard	Class
Europe	EN 13501-1	A2-s1,d0

The glass wool core of the tiles is tested and classified as non-combustible according to EN ISO 1182.



Humidity Resistance

Product		According to EN 13964:2014
Standard	Class C, RH 95% and 30°C	
Plant	Class A, RH 70% and 25°C	



Visual appearance

White Frost, nearest NCS colour sample S 0500-N, 85% light reflectance. Gloss < 1.



Cleanability

Daily dusting and vacuum cleaning. Weekly wet wiping.



Accessibility

The tiles in size 600x600 and 1200x600 are easily demountable. The tiles in size 1200x1200 and XL sizes are demountable. Minimum demounting depth according to installation diagrams.



Installation

Installed according to installation diagrams, installation guides and drawing aid. For information regarding minimum overall depth of system see quantity specification. The systems are not recommended for small rooms (approximately 2x2 m²). Ceilings with a large amount of integrations require careful planning, design and installation.



System weight

The weight of the system (including suspension grid) should be approximately 3-4 kg/m².



Mechanical properties

See table about Max live load and Min load bearing capacity and Functional demands, Mechanical properties at www.ecophon.com.



CE

Ecophon ceiling systems are CE marked according to the European harmonized standard EN 13964:2014. CE marked construction products are covered by a Declaration of Performance (DOP) which enables customers and users to easily compare performance of products available on the European market.

INSTALLATION DIAGRAM (M202) FOR ECOPHON FOCUS DG 600X600, 1200X600 MM

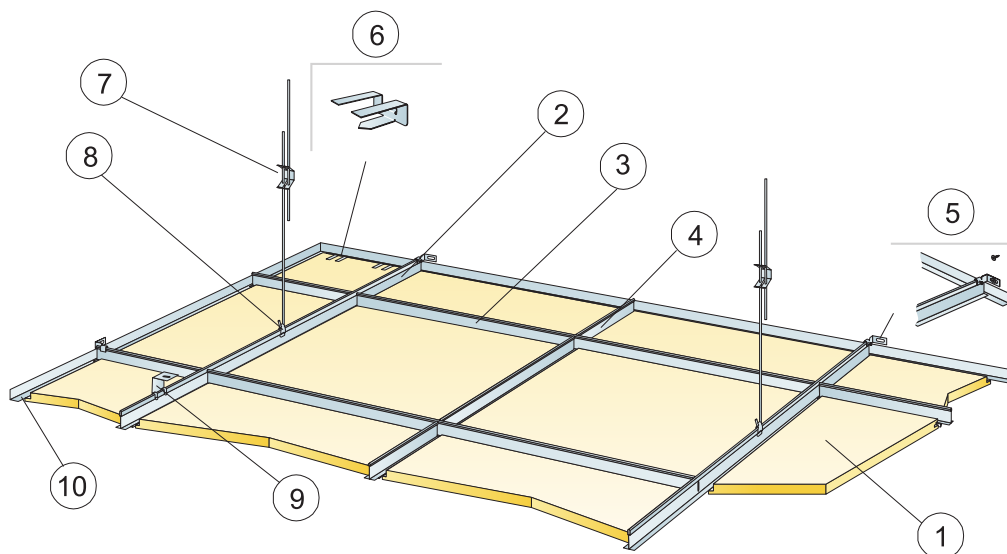

© Ecophon Group

QUANTITY SPECIFICATION (EXCL. WASTAGE)

	Size, mm	
	600x600	1200x600
1 Focus Dg	2,8/m ²	1,4/m ²
2 Connect T24 Main runner HD, installed at 1200 mm centres (max. distance from wall 600 mm, can be extended up to 1200 mm if no live load between Main runner and wall).	0,9m/m ²	0,9m/m ²
3 Connect T24 Cross tee, l=1200 mm, installed at 600 mm centres	1,7m/m ²	1,7m/m ²
4 Connect T24 Cross tee, l=600 mm	0,9m/m ²	-
5 Connect Wall Bracket for T-profiles	1/suspended row of Main runner	
6 Connect Support clip Dg20	1/300-400mm on any cut edge	
7 Connect Adjustable Hanger, installed at 1200 mm centres (max. distance from wall 600 mm)	0,7/m ²	0,7/m ²
8 Connect Hanger Clip (not to be used in swimming hall environments)	0,7/m ²	0,7/m ²
9 For direct installation: Connect Direct Bracket, installed at 1200 mm centres	0,7/m ²	0,7/m ²
10 Connect Angle trim, fixed at 300 mm centres	as required	as required
Δ Min. overall depth of system, with Adjustable hanger: 115 mm, with Direct bracket: 65 mm	-	-
δ Min. demounting depth: 30 mm	-	-
For luminaire integration in panels use Connect Bridging	-	-

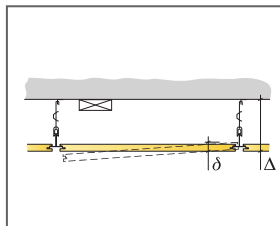

See Quantity specification

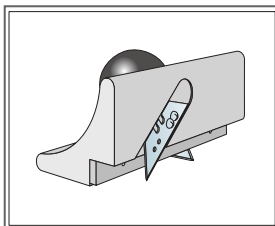

Cutting tool Dg

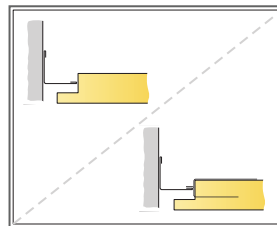

Cut edge with and without support clip

Size, mm	Max live load (N)	Min load bearing capacity (N)
600x600	50	160
1200x600	50	160

Live load/load bearing capacity

INSTALLATION DIAGRAM (M203) FOR ECOPHON FOCUS DG 1200X1200 MM

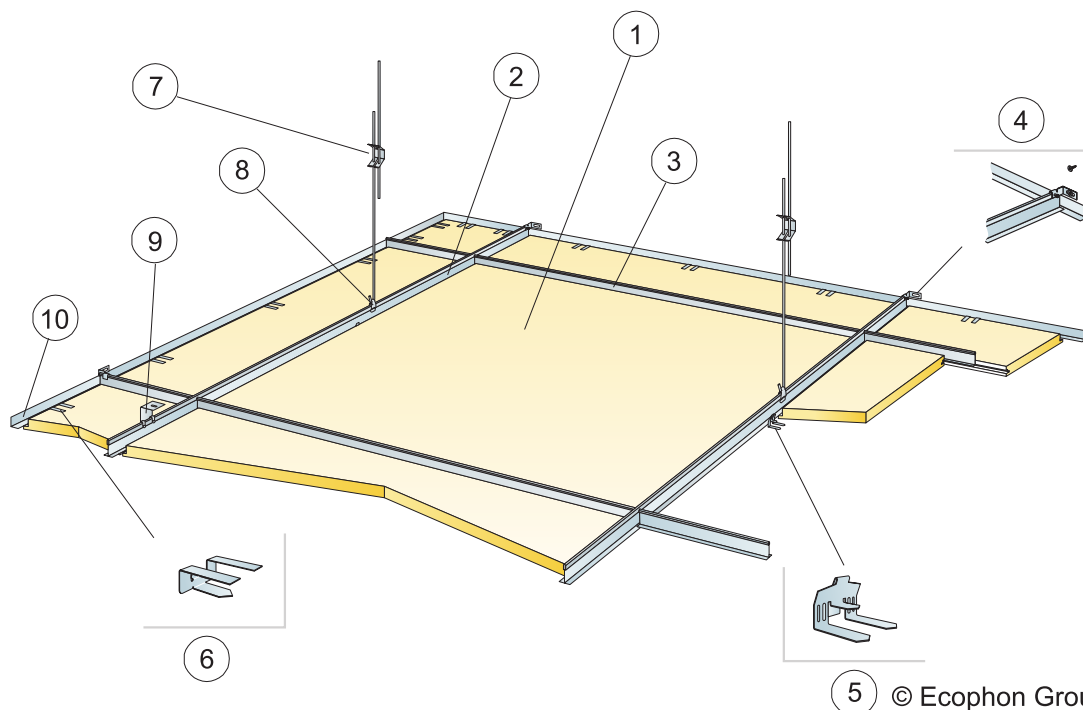

QUANTITY SPECIFICATION [EXCL. WASTAGE]

	Size, mm
	1200x1200
1 Focus Dg	0,7/m ²
2 Connect T24 Main runner HD, installed at 1200 mm centres (max. distance from wall 600 mm, can be extended up to 1200 mm if no live load between Main runner and wall).	0,9m/m ²
3 Connect T24 Cross tee, L=1200 mm, installed at 1200 mm centres	0,9m/m ²
4 Connect Wall Bracket for T-profiles	1/suspended row of Main runner
5 Connect Edge clip	1,4/m ²
6 Connect Support clip DG25	1/300-400mm on any cut edge
7 Connect Adjustable Hanger, installed at 1200 mm centres (max. distance from wall 600 mm)	0,7/m ²
8 Connect Hanger Clip (not to be used in swimming hall environments)	0,7/m ²
9 For direct installation: Connect Direct Bracket, installed at 1200 mm centres	0,7/m ²
10 Connect Angle trim, fixed at 300 mm centres	as required
Δ Min. overall depth of system, with Adjustable hanger: 115 mm, with Direct bracket: 65 mm	-
δ Min. demounting depth: 30 mm	-
For luminaire integration in panels use Connect Bridging	-

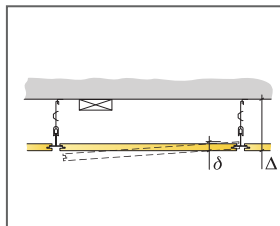

See Quantity specification

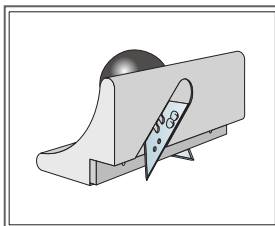

Cutting tool Dg

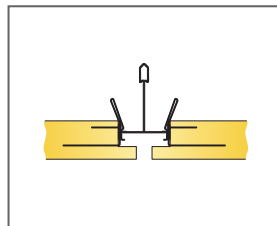

Joint between two unsupported edges with Edge clip

Size, mm	Max live load (N)	Min load bearing capacity (N)
1200x1200	50	160

Live load/load bearing capacity

INSTALLATION DIAGRAM (M204) FOR ECOPHON FOCUS DG XL

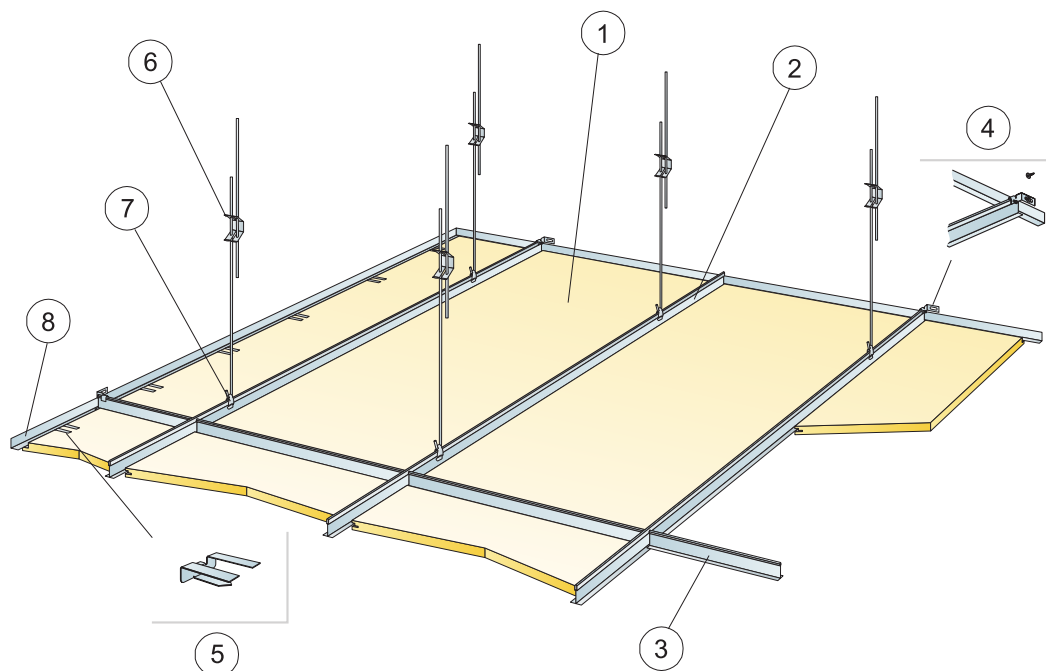

© Ecophon Group

QUANTITY SPECIFICATION (EXCL. WASTAGE)

	Size, mm			
	1600x600	1800x600	2000x600	2400x600
1 Focus Dg XL	1,05/m ²	0,95/m ²	0,85/m ²	0,7/m ²
2 Connect T24 Main runner HD, installed at 600 mm centres	1,7m/m ²	1,7m/m ²	1,7m/m ²	1,7m/m ²
3 Connect T24 Cross tee, L=600 mm	0,65m/m ²	0,6m/m ²	0,5m/m ²	0,45m/m ²
4 Connect Wall Bracket for T-profiles	1/suspended row of Main runner			
5 Connect Support clip Dg20	1pc/300-400 mm on every cut perimeter tile with only 1 supporting edge			
6 Connect Adjustable hanger, installed at 1500 mm centres (max. distance from wall 450 mm)	1,1/m ²	1,1/m ²	1,1/m ²	1,1/m ²
7 Connect Hanger clip	1,1/m ²	1,1/m ²	1,1/m ²	1,1/m ²
8 Connect Angle trim, fixed at 300 mm centres	as required	as required	as required	as required
Δ Min. overall depth of system: 115 mm	-	-	-	-
δ Min. demounting depth: 30 mm	-	-	-	-

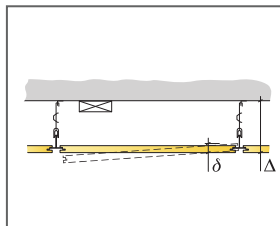

See Quantity specification

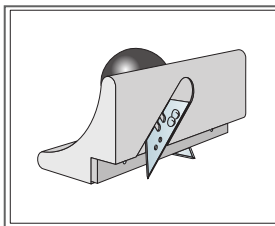

Cutting tool Dg

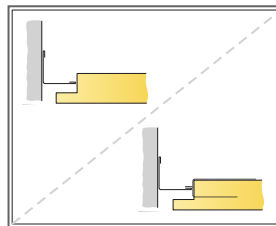

Cut edge with and without support clip

Size, mm	Max live load (N)	Min load bearing capacity (N)
1600x600	50	160
1800x600	50	160
2000x600	50	160
2400x600	50	160

Live load/load bearing capacity

Ecophon Focus™ D/A

Ecophon Focus™ DA features an edge D on the long side and edge A on the short side. Each panel is individually demounted. Fulfills the strictest functional and aesthetic demands. Especially developed for corridor and bandraster solutions where long panels are required.



Eneco Head Office, Rotterdam, Netherlands

SYSTEM RANGE

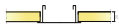

Size, mm	XL 1720x600	XL 2000x600	XL 2400x600
T24	•	•	•
Thickness (THK)	20	20	20
Inst. Diagr.	M17	M17	M17



Focus D/A tile



Focus D/A for Bandraستر



Acoustic

Sound Absorption:

Test results according to EN ISO 354. Classification according to EN ISO 11654, and the single value ratings for Noise Reduction Coefficient, NRC and Sound Absorption Average, SAA according to ASTM C 423.

α_p , Practical sound absorption coefficient

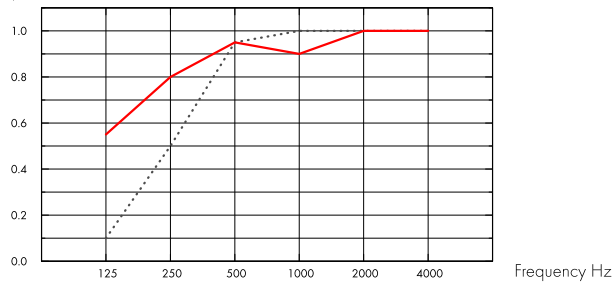

..... Focus D/A 20 mm, 60 mm o.d.s.

— Focus D/A 20 mm, 200 mm o.d.s.

THK mm	o.d.s. mm	α_p , Practical sound absorption coefficient						α_w	Sound absorption class
		125 Hz	250 Hz	500 Hz	1000 Hz	2000 Hz	4000 Hz		
20	60	0.10	0.50	0.95	1.00	1.00	1.00	0.80	A
20	200	0.55	0.80	0.95	0.90	1.00	1.00	0.95	A

THK mm	o.d.s. mm	NRC	SAA
20	60	0.90	0.89
20	400	0.80	0.82

THK mm	AC(1.5)	D_{nfw}	CAC dB
	Articulation Class, ASTM E1111, ASTM E1110	Weighted normalized flanking level difference, ISO 10848-2	Ceiling Attenuation Class, ASTM 1414, ASTM E413
20	180	24	25



Indoor Air Quality

Certificate / Label	Standard	Plant
Eurofins Indoor Air Comfort®	IAC	IAC Gold
French VOC	A	A+
Finnish M1	•	•



Environmental Footprint

	Kg CO ₂ equiv/m ²
Focus DA	4,32 (Focus family EPD in conformity with ISO 14025 / EN 15804)



Circularity

Minimum post-consumer recycled content	57%
Recyclability	Fully recyclable



Fire safety

Country	Standard	Class
Europe	EN 13501-1	A2-s1,d0

The glass wool core of the tiles is tested and classified as non-combustible according to EN ISO 1182.



Humidity Resistance

Product	According to EN 13964:2014	
Standard	Class C, RH 95% and 30°C	
Plant	Class A, RH 70% and 25°C	



Visual appearance

White Frost, nearest NCS colour sample S 0500-N, 85% light reflectance. Gloss < 1.



Cleanability

Daily dusting and vacuum cleaning. Weekly wet wiping.



Accessibility

The tiles are easily demountable. Minimum demounting depth according to installation diagrams.



Installation

Installed according to installation diagram and bandraster/grid supplier recommendations.



System weight

The weight of the system (including suspension grid) should be approximately 2 kg/m².



Mechanical properties

See table about Max live load and Min load bearing capacity and Functional demands, Mechanical properties at www.ecophon.com.



CE

Ecophon ceiling systems are CE marked according to the European harmonized standard EN 13964:2014. CE marked construction products are covered by a Declaration of Performance (DOP) which enables customers and users to easily compare performance of products available on the European market.

INSTALLATION DIAGRAM (M17) FOR FOCUS D/A IN CORRIDOR

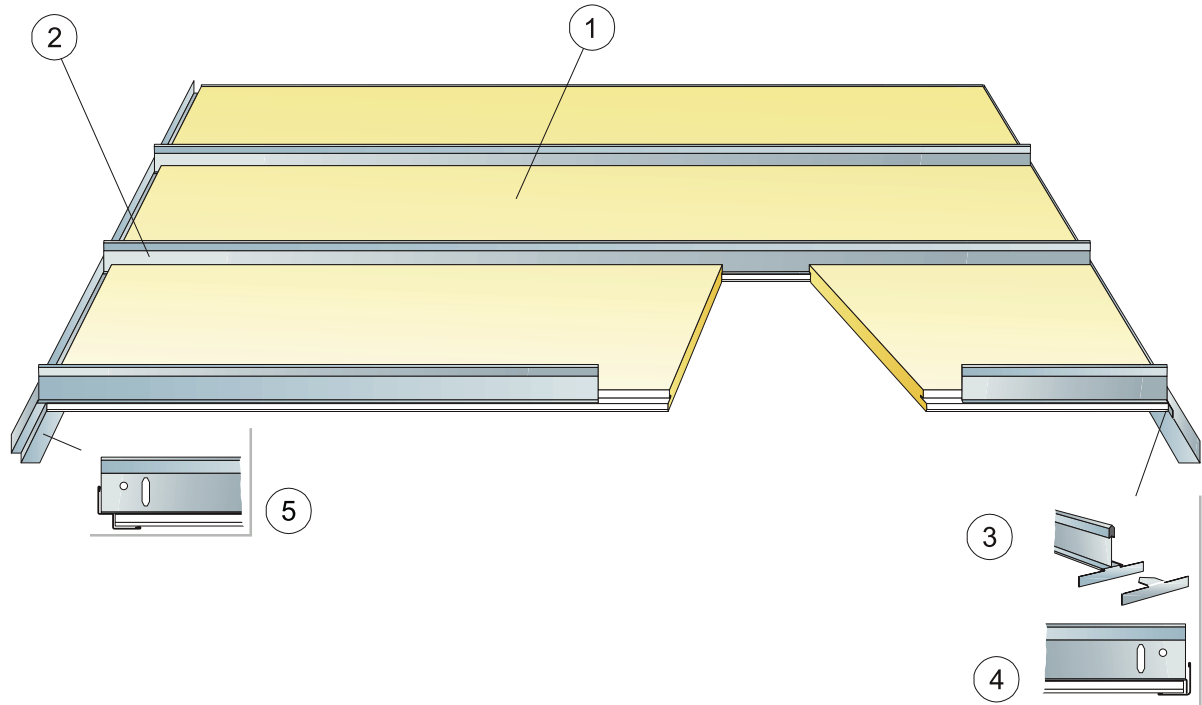

QUANTITY SPECIFICATION (EXCL. WASTAGE)

	Size, mm		
	1720x600	2000x600	2400x600
1 Focus D/A for corridors	0,97/m ²	0,85/m ²	0,7/m ²
2 Connect T24 Corridor profile, installed at 600 mm centres	0,95/m ²	0,85/m ²	0,7/m ²
3 Connect End fixing plate	1,95/m ²	1,7/m ²	1,4/m ²
4 Connect Angle trim, fixed at 200 mm centres	as required	as required	as required
5 Connect Shadow-line trim, fixed at 200 mm centres	as required	as required	as required
Δ Min. overall depth of system: 50 mm	-	-	-
δ Min. demounting depth: 75 mm	-	-	-

Ecophon Focus™ E

Ecophon Focus™ E has a recessed visible grid and a tegular edge, creating a ceiling with a shadow effect that accentuates each tile and partially conceals the grid. For applications where an attractive suspended ceiling is required and easy removal of individual tiles is essential.



Vilhelms Fastigheter, Helsingborg, Sweden

SYSTEM RANGE

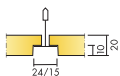

Size, mm	600x600	625x625	1200x600	1200x1200	XL 1600x600	XL 1800x600	XL 2000x600	XL 2400x600
Connect T15	•		•	•				
Connect T24	•	•	•	•	•	•	•	•
Thickness (THK)	20	20	20	20	20	20	20	20
Inst. Diagr.	M12	M12 DIN	M12	M12	M47, M49	M47, M49	M47, M49	M47, M49

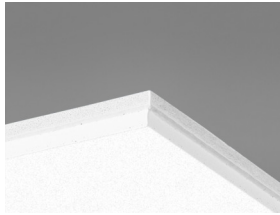

Focus E tile

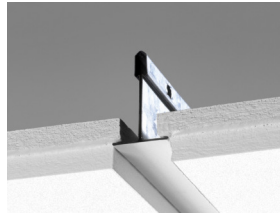

Section of Focus E system with Connect T24

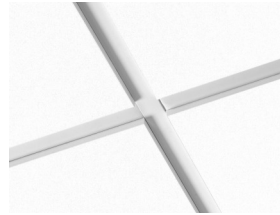

Focus E system

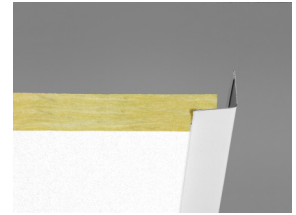

Focus E with Connect Angle trim



Acoustic

Sound Absorption:

Test results according to EN ISO 354. Classification according to EN ISO 11654, and the single value ratings for Noise Reduction Coefficient, NRC and Sound Absorption Average, SAA according to ASTM C 423.

α_p , Practical sound absorption coefficient

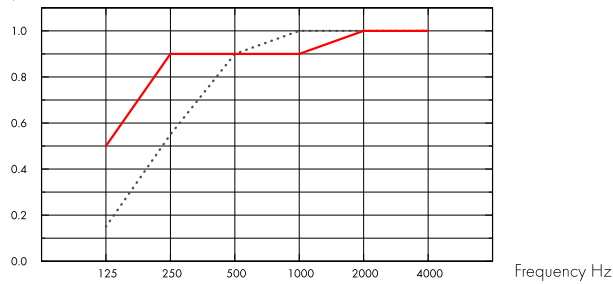

..... Focus E 20 mm, 60 mm o.d.s.

— Focus E 20 mm, 200 mm o.d.s.

THK mm	o.d.s. mm	α_p , Practical sound absorption coefficient						α_w	Sound absorption class
		125 Hz	250 Hz	500 Hz	1000 Hz	2000 Hz	4000 Hz		
20	60	0.15	0.55	0.90	1.00	1.00	1.00	0.85	B
20	200	0.50	0.90	0.90	0.90	1.00	1.00	0.95	A

THK mm	o.d.s. mm	NRC	SAA
20	60	0.90	0.87
20	400	0.85	0.85

THK mm	AC(1.5) Articulation Class, ASTM E1111, ASTM E1110	D_{nfw} Weighted normalized flanking level difference, ISO 10848-2	CAC dB Ceiling Attenuation Class, ASTM 1414, ASTM E413
20	180	22	23



Indoor Air Quality

Certificate / Label	Standard	Plant
Eurofins Indoor Air Comfort®	IAC	IAC Gold
French VOC	A	A+
Finnish M1	•	•





Environmental Footprint

Kg CO ₂ equiv/m ²	
Focus E	3,66 (Focus family EPD in conformity with ISO 14025 / EN 15804)
Focus E/Plant	2,35 (Focus E/Plant EPD in conformity with ISO 14025 / EN 15804)



Circularity

Minimum post-consumer recycled content	55%
Recyclability	Fully recyclable



Fire safety

Country	Standard	Class
Europe	EN 13501-1	A2-s1,d0

The glass wool core of the tiles is tested and classified as non-combustible according to EN ISO 1182.



Humidity Resistance

Product		According to EN 13964:2014
Standard	Class C, RH 95% and 30°C	
Plant	Class A, RH 70% and 25°C	



Visual appearance

White Frost, nearest NCS colour sample S 0500-N, 85% light reflectance. Gloss < 1.



Cleanability

Daily dusting and vacuum cleaning. Weekly wet wiping.



Accessibility

The tiles are easily demountable. Minimum demounting depth according to installation diagrams.



Installation

Installed according to installation diagrams, installation guides and drawing aid. For information regarding minimum overall depth of system see quantity specification.



System weight

The weight of the system (including suspension grid) should be approximately 3 kg/m².



Mechanical properties

See table about Max live load and Min load bearing capacity and Functional demands, Mechanical properties at www.ecophon.com.



CE

Ecophon ceiling systems are CE marked according to the European harmonized standard EN 13964:2014. CE marked construction products are covered by a Declaration of Performance (DOP) which enables customers and users to easily compare performance of products available on the European market.

INSTALLATION DIAGRAM (M12) FOR ECOPHON FOCUS E

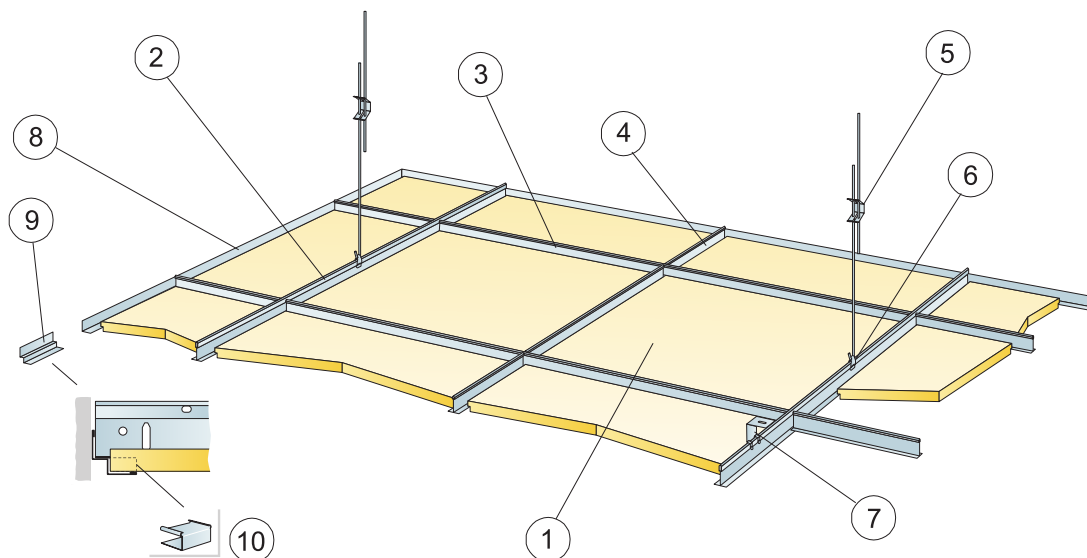

© Ecophon Group

QUANTITY SPECIFICATION (EXCL. WASTAGE)

	Size, mm		
	600x600	1200x600	1200x1200
1 Focus E T24 or T15	2,8/m ²	1,4/m ²	0,7/m ²
2 Connect T24 or T15 Main runner, installed at 1200 mm centres (max. distance from wall 600 mm, can be extended up to 1200 mm if no live load between Main runner and wall).	0,9m/m ²	0,9m/m ²	0,9m/m ²
3 Connect T24 or T15 Cross tee, L=1200 mm	1,7m/m ²	1,7m/m ²	0,9m/m ²
4 Connect T24 or T15 Cross tee, L=600 mm	0,9m/m ²	-	-
5 Connect Adjustable Hanger, installed at 1200 mm centres (max. distance from wall 600 mm)	0,7/m ²	0,7/m ²	0,7/m ²
6 Connect Hanger Clip (not to be used in swimming hall environments)	0,7/m ²	0,7/m ²	0,7/m ²
7 For direct installation: Connect Direct Bracket, installed at 1200 mm centres	0,7/m ²	0,7/m ²	0,7/m ²
8 Connect Angle trim, fixed at 300 mm centres	as required	as required	as required
9 Connect Shadow-line trim, fixed at 300 mm centres	as required	as required	as required
10 Connect E-plug (for Shadow-line trim)	as required	as required	as required
Δ Min. overall depth of system, with adjustable hanger: 110 mm, with direct bracket: 60 mm	-	-	-
δ Min. demounting depth: 120 mm, (1200x1200 mm, T15: 160 mm)	-	-	-
For luminaire integration in panels use Connect Bridging	-	-	-

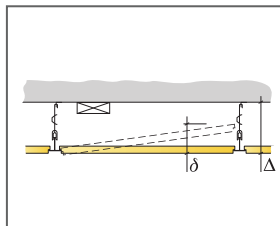

See Quantity specification

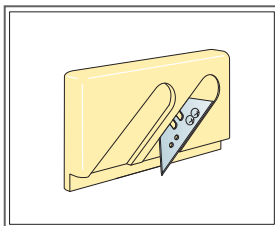

Cutting tool E

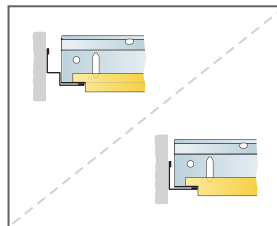

Regular rebate with angle trim and T-profile on foot of shadow-line trim.

Size, mm	Max live load (N)	Min load bearing capacity (N)
600x600	50	160
1200x600	50	160
1200x1200	50	160

Live load/load bearing capacity

INSTALLATION DIAGRAM (M12) FOR ECOPHON FOCUS E

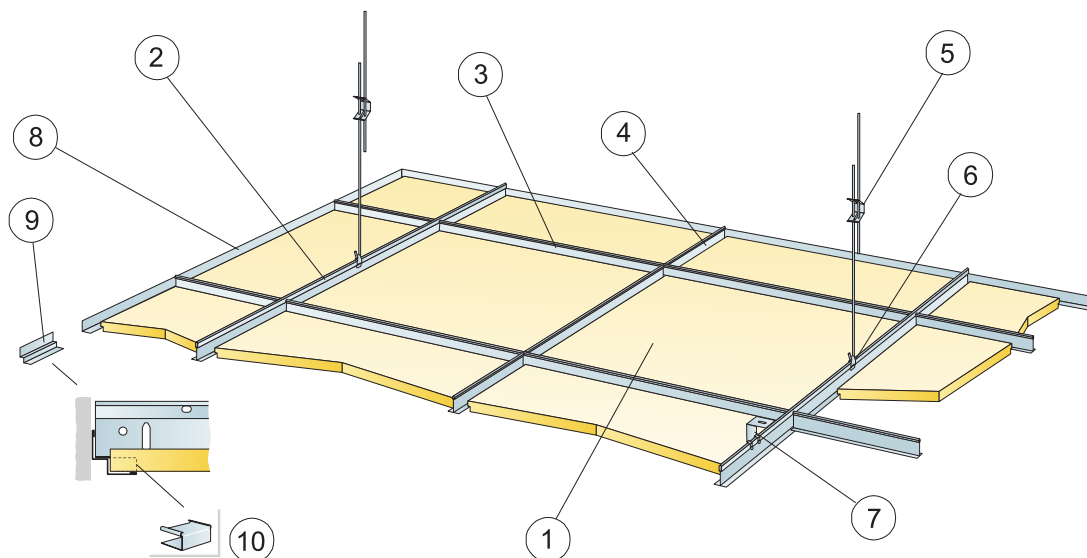

© Ecophon Group

QUANTITY SPECIFICATION (EXCL. WASTAGE)

		Size, mm
		625x625
1	Focus E T24 or T15	2,6/m ²
2	Connect T24 Main Runner, installed at 1250 mm centres for DIN [only white profiles]	0,8m/m ²
3	Connect T24 or T15 Cross Tee, L=1250 mm, installed at 625 mm centres	1,6m/m ²
4	Connect T24 or T15 Cross Tee, L=625 mm	0,8m/m ²
5	Connect Adjustable Hanger, installed at 1250 mm centres [max. distance from wall 600 mm]	0,7/m ²
6	Connect Hanger Clip (not to be used in swimming hall environments)	0,7/m ²
7	For direct installation: Connect Direct Bracket, installed at 1250 mm centres	0,7/m ²
8	Connect Angle trim, fixed at 300 mm centres	as required
9	Connect Shadow-line trim, fixed at 300 mm centres	as required
10	Connect E-plug (for Shadow-line trim)	as required
Δ Min. overall depth of system, with adjustable hanger: 110 mm, with direct bracket: 60 mm		-
δ Min. demounting depth: 120 mm		-
For luminaire integration in panels use Connect Bridging		-

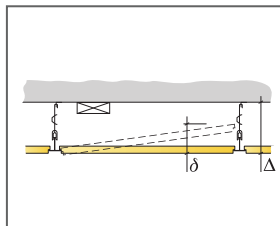

See Quantity specification

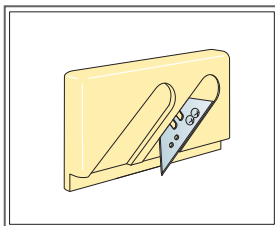

Cutting tool E

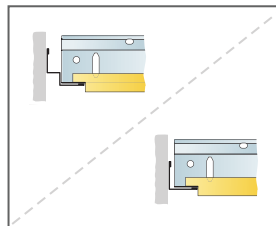

Regular rebate with angle trim and T-profile on foot of shadow-line trim.

Size, mm	Max live load (N)	Min load bearing capacity (N)
625x625	35	160

Live load/load bearing capacity

INSTALLATION DIAGRAM (M47) FOR ECOPHON FOCUS E XL

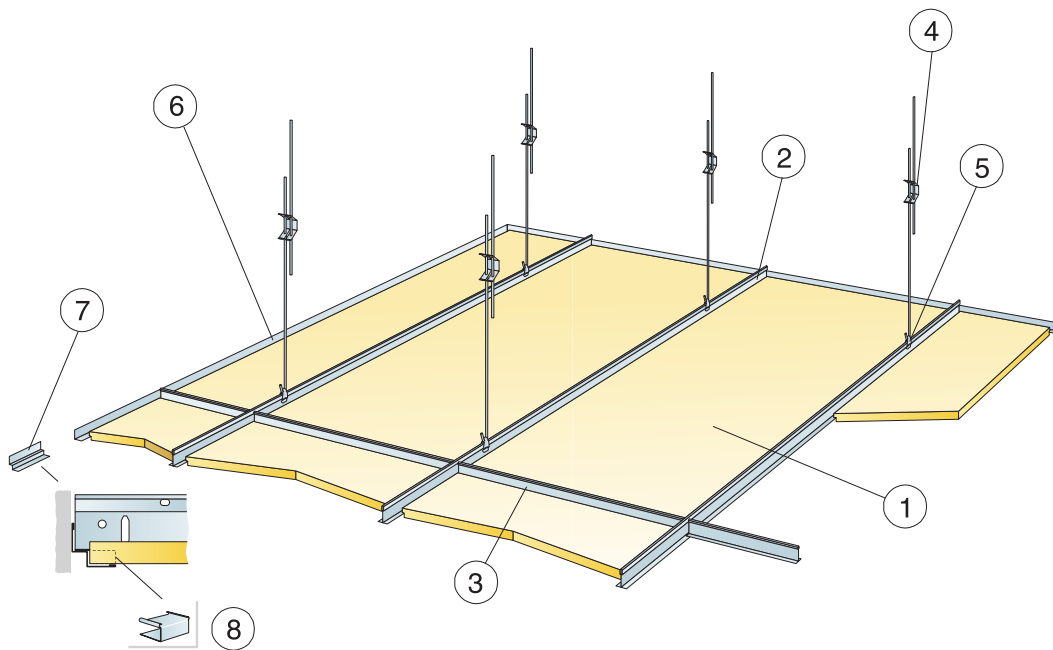

© Ecophon Group

QUANTITY SPECIFICATION (EXCL. WASTAGE)

	Size, mm			
	1600x600	1800x600	2000x600	2400x600
1 Focus E	1,05/m ²	0,95/m ²	0,85/m ²	0,7/m ²
2 Connect T24 Main runner, installed at 600 mm centres	1,7m/m ²	1,7m/m ²	1,7m/m ²	1,7m/m ²
3 Connect T24 Cross tee, L=600 mm	0,65m/m ²	0,6m/m ²	0,5m/m ²	0,45m/m ²
4 Connect Adjustable hanger, installed at 1500 mm centres (max. distance from wall 450 mm)	1,1/m ²	1,1/m ²	1,1/m ²	1,1/m ²
5 Connect Hanger clip	1,1/m ²	1,1/m ²	1,1/m ²	1,1/m ²
6 Connect Angle trim, fixed at 300 mm centres	as required	as required	as required	as required
7 Connect Shadow-line trim, fixed at 300 mm centres	as required	as required	as required	as required
8 Connect E-plug (for Shadow-line trim)	as required	as required	as required	as required
Δ Min. overall depth of system: 110 mm	-	-	-	-
δ Minimum demounting depth: 110 mm	-	-	-	-

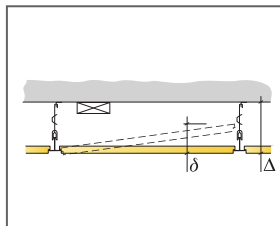

See Quantity specification

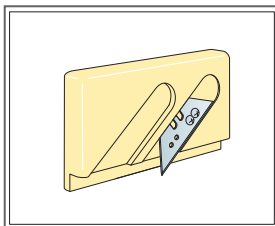

Cutting tool E

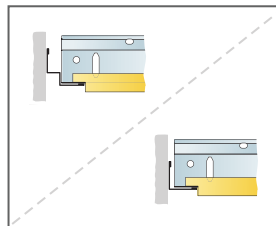

Regular rebate with angle trim and T-profile on foot of shadow-line trim.

Size, mm	Max live load (N)	Min load bearing capacity (N)
1600x600	50	160
1800x600	50	160
2000x600	50	160
2400x600	50	160

Live load/load bearing capacity

INSTALLATION DIAGRAM (M49) FOR ECOPHON FOCUS E XL IN CORRIDORS

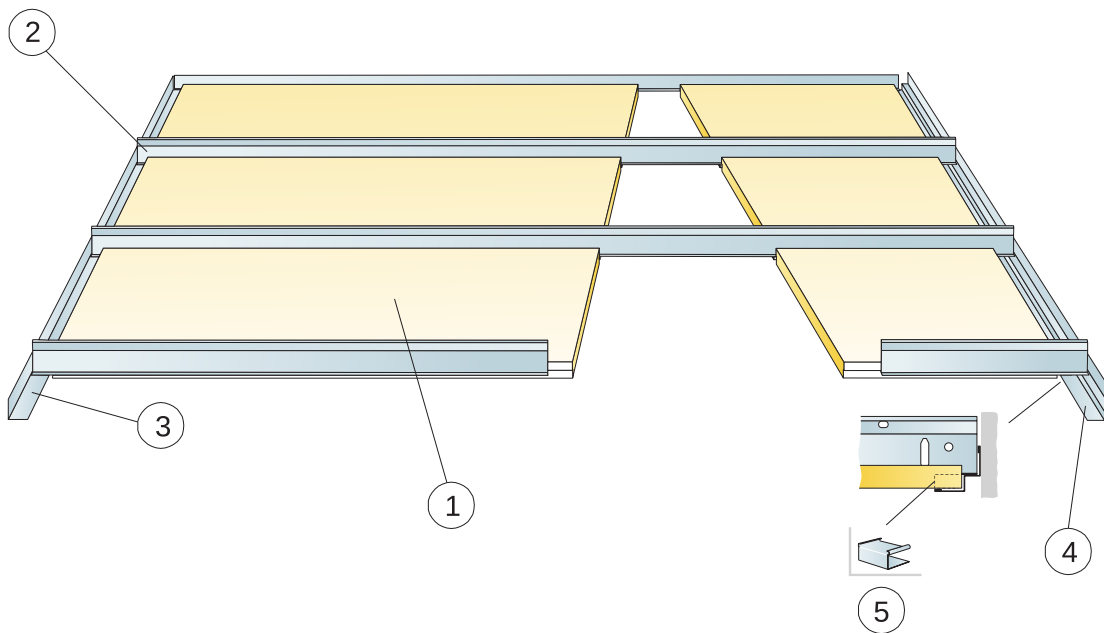

© Ecophon Group

QUANTITY SPECIFICATION (EXCL. WASTAGE)

	Size, mm			
	1600x600	1800x600	2000x600	2400x600
1 Focus E	1,05/m ²	0,95/m ²	0,85/m ²	0,7/m ²
2 Connect T24 Corridor profile, installed at 600 mm centres	1,05/m ²	0,95/m ²	0,85/m ²	0,7/m ²
3 Connect Angle trim, fixed at 200 mm centres	as required	as required	as required	as required
4 Connect Shadow-line trim, fixed at 200 mm centres	as required	as required	as required	as required
5 Connect Eplug (for Shadow-line trim)	as required	as required	as required	as required
Δ Min. overall depth of system: 50 mm	-	-	-	-
δ Min. demounting depth: 75 mm	-	-	-	-

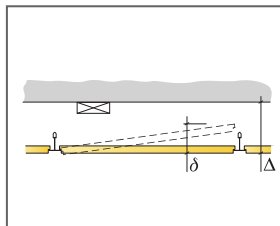

See Quantity specification

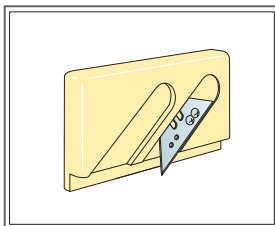

Cutting tool E

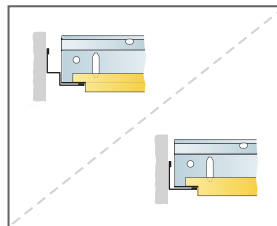

Regular rebate with angle trim and T-profile on foot of shadow-line trim.

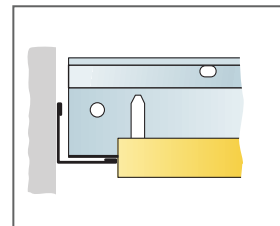

Straight cut with T-profiles resting on wall trim

Ecophon Focus™ Ez

Ecophon Focus™ Ez has a recessed visible grid with diagonal edge design, creating a new design feature to the ceiling. For applications with high demands on good acoustics and speech intelligibility.



SYSTEM RANGE



Size, mm	600x600
T24	•
Thickness (THK)	40
Inst. Diag.	M393

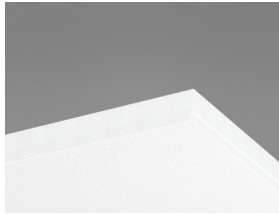

Focus Ez tile

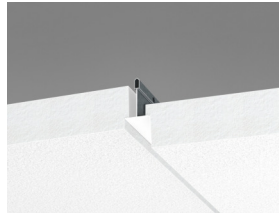

Section of Focus Ez system with Connect T24



Focus Ez system



Acoustic

Sound Absorption:

Test results according to EN ISO 354. Classification according to EN ISO 11654, and the single value ratings for Noise Reduction Coefficient, NRC and Sound Absorption Average, SAA according to ASTM C 423.

α_p , Practical sound absorption coefficient

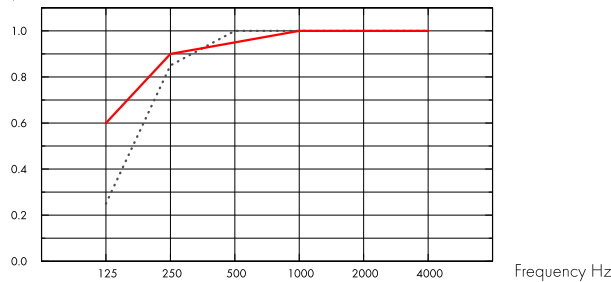

..... Focus Ez 40 mm, 60 mm o.d.s.
 — Focus Ez 40 mm, 200 mm o.d.s.

THK mm	o.d.s. mm	α_p , Practical sound absorption coefficient						α_w	Sound absorption class
		125 Hz	250 Hz	500 Hz	1000 Hz	2000 Hz	4000 Hz		
40	60	0.25	0.85	1.00	1.00	1.00	1.00	1.00	A
40	200	0.60	0.90	0.95	1.00	1.00	1.00	1.00	A

THK mm	o.d.s. mm	NRC	SAA
40	60	1.00	0.99
40	200	1.00	0.97

THK mm	AC(1.5) Articulation Class, ASTM E1111, ASTM E1110	D_{nfw} Weighted normalized flanking level difference, ISO 10848-2	CAC dB Ceiling Attenuation Class, ASTM 1414, ASTM E413
40	200	29	31



Indoor Air Quality

Certificate / Label	Standard	Plant
Eurofins Indoor Air Comfort®	IAC	IAC Gold
French VOC	A	A+
Finnish M1	•	•



Environmental Footprint

	Kg CO ₂ equiv/m ²
Focus Ez	5,9 (Focus family EPD in conformity with ISO 14025 / EN 15804)



Circularity

Minimum post-consumer recycled content	59%
Recyclability	Fully recyclable



Fire safety

Country	Standard	Class
Europe	EN 13501-1	A2-s1,d0

The glass wool core of the tiles is tested and classified as non-combustible according to EN ISO 1182.



Humidity Resistance

Product	According to EN 13964:2014	
Standard	Class C, RH 95% and 30°C	
Plant	Class A, RH 70% and 25°C	



Visual appearance

White Frost, nearest NCS colour sample S 0500-N, 85% light reflectance. Gloss < 1.



Cleanability

Daily dusting and vacuum cleaning. Weekly wet wiping.



Accessibility

The tiles are easily demountable. Minimum demounting depth according to installation diagrams.



Installation

Installed according to installation diagrams, installation guides and drawing aid. For information regarding minimum overall depth of system see quantity specification.



System weight

The weight of the system (including suspension grid) should be approximately 5 kg/m²



Mechanical properties

See table about Max live load and Min load bearing capacity and Functional demands, Mechanical properties at www.ecophon.com.



CE

Ecophon ceiling systems are CE marked according to the European harmonized standard EN 13964:2014. CE marked construction products are covered by a Declaration of Performance (DOP) which enables customers and users to easily compare performance of products available on the European market.

INSTALLATION DIAGRAM (M393) FOR ECOPHON FOCUS EZ

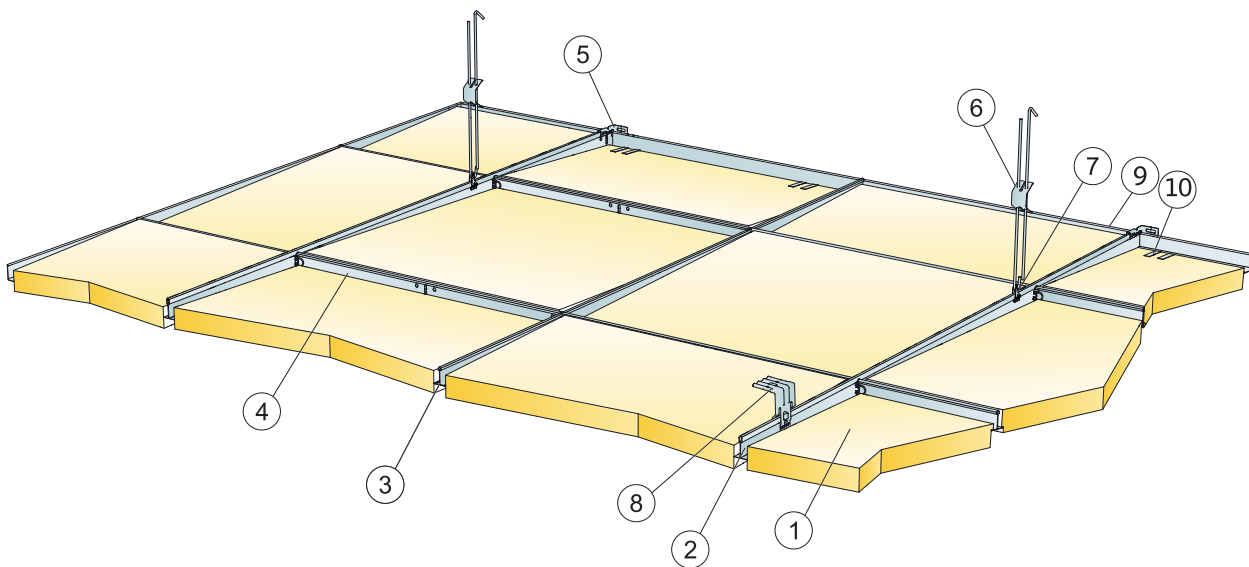

QUANTITY SPECIFICATION (EXCL. WASTAGE)

	Size, mm
	600x600
1 Focus Ez	2,8/m ²
2 Connect T24 Main runner, installed at 1200 mm centres (max. distance from wall 600 mm, can be extended up to 1200 mm if no live load between Main runner and wall).	0,9m/m ²
3 Connect T24 Cross tee, L=1200 mm, installed at 600 mm centres	1,7m/m ²
4 Connect T24 Cross tee, L=600 mm	0,9m/m ²
5 Connect Wall Bracket for T-profiles	1 /suspended row of Main runner
6 Connect Adjustable Hanger, installed at 1200 mm centres (max. distance from wall 600 mm)	0,7/m ²
7 Connect Hanger Clip (not to be used in swimming hall environments)	0,7/m ²
8 For direct installation: Connect Direct Bracket, installed at 1200 mm centres	0,7/m ²
9 Connect Angle trim, fixed at 300 mm centres	as required
10 Connect Support clip DG25	2/300-400mm on any cut edge
Δ Min. overall depth of system, with Adjustable hanger: 110 mm, with Direct bracket: 80 mm	-
δ Min. demounting depth: 80 mm	-

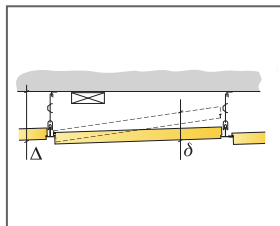

See Quantity specification

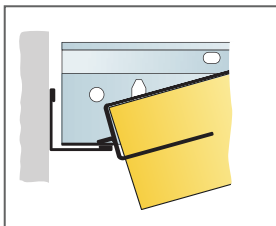

Cut edge with Connect Support clip Dg25

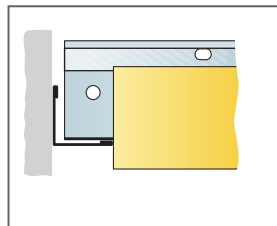

Wall connection non-supported edge

Size, mm	Max live load (N)	Min load bearing capacity (N)
600x600	40	160

Live load/load bearing capacity

Ecophon Focus™ F

Ecophon Focus™ F installs directly to an existing plaster ceiling, boarding, battens or concrete, to create a ceiling with a smooth appearance. For applications requiring a ceiling mechanically secured to the structural soffit.



Ten Con Ten, Madrid, Spain

SYSTEM RANGE

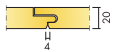

Size, mm	600x600	1200x600
Direct	•	•
Thickness (THK)	20	20
Inst. Diagr.	M15	M15

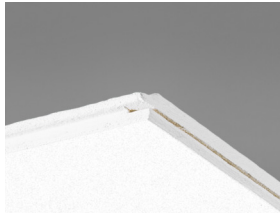

Focus F tile

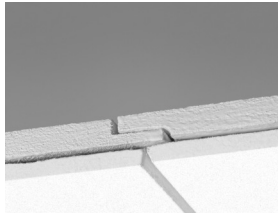

Section of Focus F system

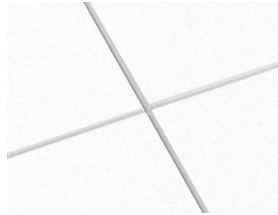

Focus F system



Focus F is installed by screw fixing



Acoustic

Sound Absorption:

Test results according to EN ISO 354. Classification according to EN ISO 11654, and the single value ratings for Noise Reduction Coefficient, NRC and Sound Absorption Average, SAA according to ASTM C 423.

α_p , Practical sound absorption coefficient

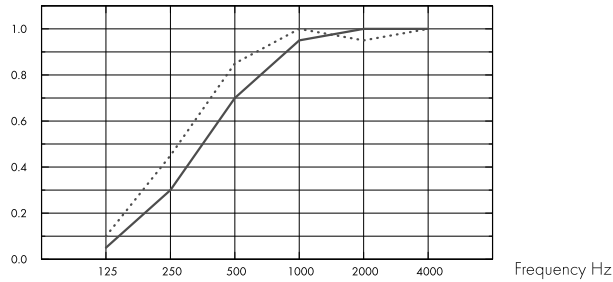

— Focus F 20 mm, 20 mm o.d.s.

.... Focus F 20 mm, 40 mm o.d.s.

THK mm	o.d.s. mm	α_p , Practical sound absorption coefficient						α_w	Sound absorption class
		125 Hz	250 Hz	500 Hz	1000 Hz	2000 Hz	4000 Hz		
20	20	0.05	0.30	0.70	0.95	1.00	1.00	0.60	C
20	40	0.10	0.45	0.85	1.00	0.95	1.00	0.75	C

THK mm	o.d.s. mm	NRC	SAA
20	20	0.75	0.77



Indoor Air Quality

Certificate / Label	Standard	Plant
Eurofins Indoor Air Comfort®	IAC	IAC Gold
French VOC	A	A+
Finnish M1	•	•



Environmental Footprint

	Kg CO ₂ equiv/m ²
Focus F	4,90 (Focus family EPD in conformity with ISO 14025 / EN 15804)
Focus F/Plant	2,76 (Focus F/Plant EPD in conformity with ISO 14025 / EN 15804)



Circularity

Minimum post-consumer recycled content	59%
Recyclability	Fully recyclable



Fire safety

Country	Standard	Class
Europe	EN 13501-1	A2-s1,d0

The glass wool core of the tiles is tested and classified as non-combustible according to EN ISO 1182.



Humidity Resistance

Product	
Standard	Class C, RH 95% and 30°C
Plant	Class A, RH 70% and 25°C

According to EN 13964:2014



Visual appearance

White Frost, nearest NCS colour sample S 0500-N, 85% light reflectance. Gloss < 1.



Cleanability

Daily dusting and vacuum cleaning. Weekly wet wiping.



Accessibility

The tiles are not demountable.



Installation

Installed according to installation diagrams, installation guides and drawing aid. For information regarding minimum overall depth of system see quantity specification. For best result the surface should be even, however an acceptable result could be achieved on slightly uneven surfaces. If very uneven surfaces - installation of furring (evenly spaced timber battens) as the substrate for the tiles is recommended.



System weight

The weight of the system should be approximately 2,5 kg/m²



Mechanical properties

Additional live load has to be fixed to the soffit.



CE

Ecophon ceiling systems are CE marked according to the European harmonized standard EN 13964:2014. CE marked construction products are covered by a Declaration of Performance (DOP) which enables customers and users to easily compare performance of products available on the European market.

INSTALLATION DIAGRAM (M15) FOR ECOPHON FOCUS F

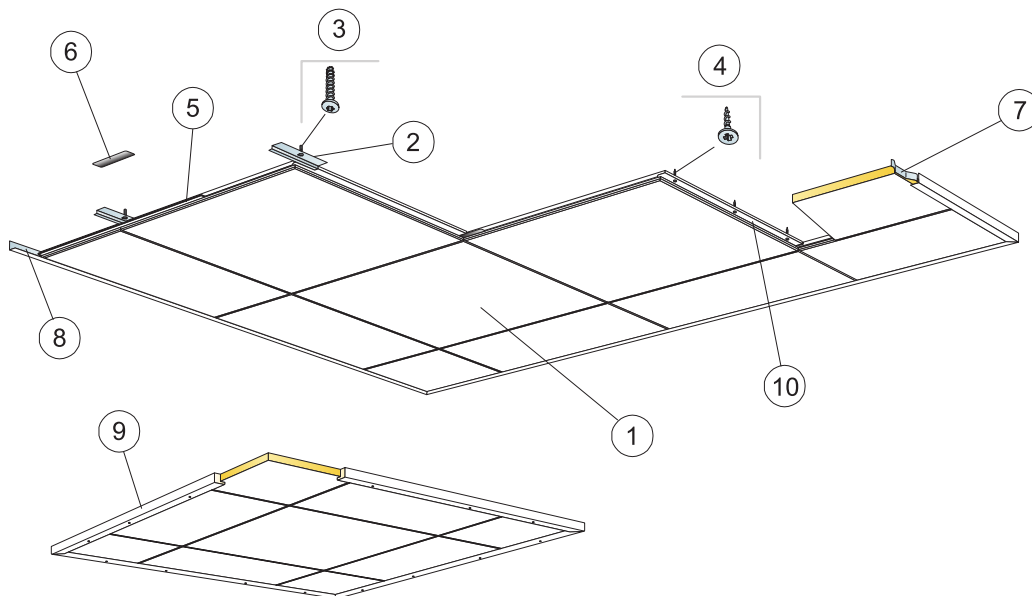

© Ecophon Group

QUANTITY SPECIFICATION (EXCL. WASTAGE)

	Size, mm	
	600x600	1200x600
1 Focus F	2,8/m ²	1,4/m ²
2 Connect Direct fixing plate, installed at 600 mm centres (for use in concrete)	2,8/m ²	2,8/m ²
3 Connect Anchor screw, installed at 600 mm centres (for use in concrete)	2,8/m ²	2,8/m ²
4 Connect Installation screw MVL (for use in plasterboard or timber)	8,3/m ²	7/m ²
5 Connect Spline F, L=600 mm. Must be used in Sweden, Denmark, Norway and Finland at fireclass 'Tändskyddande beklädnad'	2,8/m ²	1,4/m ²
6 Connect Spline, L=150 mm	2,8/m ²	1,4/m ²
7 Connect Wall spring spacer	1/panel in the last row	2/panel in the last row
8 Connect Angle trim, fixed at 300 mm centres	as required	as required
9 For use when installing floating ceilings: Connect Wood trim, L=2500 mm, fixed at 500 mm centres	as required	as required
10 Timber installed at 600 mm centres (300 mm if thermal insulation is placed above), with the screw fixings along the timber.	as required	as required
Δ Min. overall depth of system: 20 mm	-	-
δ Min. demounting depth: The system is not demountable	-	-

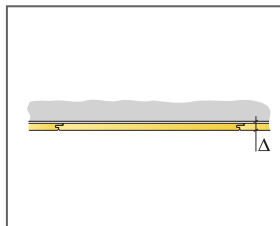

See Quantity specification

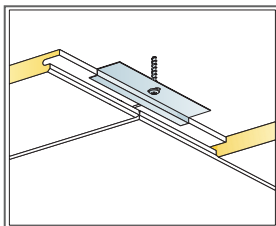

Installation in concrete

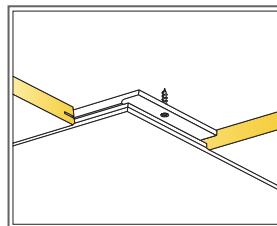

Installation in plasterboard or timber

Ecophon Focus™ Lp

Ecophon Focus™ Lp has a semi-concealed grid system used for highlighting direction in a room. Features a wide gap between tiles in the emphasised direction and a narrow gap in the other. The system consists of standard Focus™ Lp tiles and Focus™ Lp Technical tiles.



Kuopio Courthouse, Finland

SYSTEM RANGE

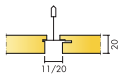

Size, mm	600x150	600x300	600x600	1200x150	1200x300	1200x600	XL 1800x600
T24	•	•	•	•	•	•	•
Thickness (THK)	20	20	20	20	20	20	20
Inst. Diagr.	M391	M390, M391	M390, M391	M391	M390, M391	M390, M391	M392

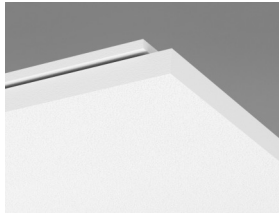

Focus Lp tile

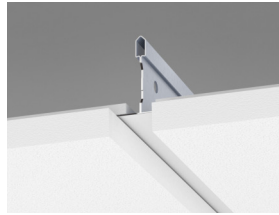

Section of Focus Lp system with Connect T24 Main runner

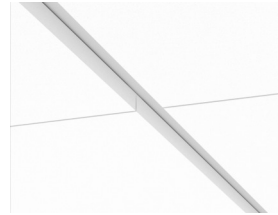

Focus Lp system

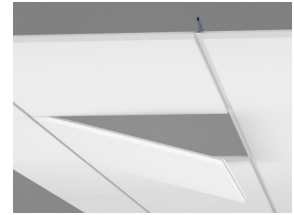

Demounting of tile



Acoustic

Sound Absorption:

Test results according to EN ISO 354. Classification according to EN ISO 11654, and the single value ratings for Noise Reduction Coefficient, NRC and Sound Absorption Average, SAA according to ASTM C 423.

α_p , Practical sound absorption coefficient

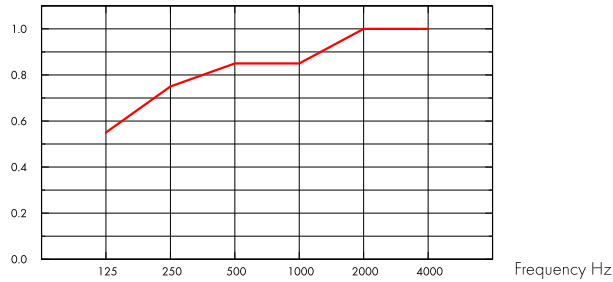

— Focus Lp 20 mm, 200 mm o.d.s.

THK mm	o.d.s. mm	α_p , Practical sound absorption coefficient						α_w	Sound absorption class
		125 Hz	250 Hz	500 Hz	1000 Hz	2000 Hz	4000 Hz		
20	200	0.55	0.75	0.85	0.85	1.00	1.00	0.90	A

THK mm	o.d.s. mm	NRC	SAA
20	400	0.80	0.82

THK mm	AC(1.5)	D_{nfw}	CAC dB
	Articulation Class, ASTM E1111, ASTM E1110	Weighted normalized flanking level difference, ISO 10848-2	Ceiling Attenuation Class, ASTM 1414, ASTM E413
20	180	24	25



Indoor Air Quality

Certificate / Label	Standard	Plant
Eurofins Indoor Air Comfort®	IAC	IAC Gold
French VOC	A	A+
Finnish M1	•	•



Environmental Footprint

	Kg CO ₂ equiv/m ²
Focus Lp	4,66 (Focus family EPD in conformity with ISO 14025 / EN 15804)
Focus Lp/Plant	2,76 (Focus Lp/Plant EPD in conformity with ISO 14025 / EN 15804)



Circularity

Minimum post-consumer recycled content	57%
Recyclability	Fully recyclable



Fire safety

Country	Standard	Class
Europe	EN 13501-1	A2-s1,d0

The glass wool core of the tiles is tested and classified as non-combustible according to EN ISO 1182.



Humidity Resistance

Product	According to EN 13964:2014	
Standard	Class C, RH 95% and 30°C	
Plant	Class A, RH 70% and 25°C	



Visual appearance

White Frost, nearest NCS colour sample S 0500-N, 85% light reflectance. Gloss < 1.



Cleanability

Daily dusting and vacuum cleaning. Weekly wet wiping.



Accessibility

The tiles are easily demountable. Minimum demounting depth according to installation diagrams.



Installation

Installed according to installation diagrams, installation guides and drawing aid. For information regarding minimum overall depth of system see quantity specification. The systems are not recommended for small rooms (approximately 2x2 m²). Ceilings with a large amount of integrations require careful planning, design and installation.



System weight

The weight of the system (including suspension grid) should be approximately 3-4 kg/m².



Mechanical properties

See table about Max live load and Min load bearing capacity and Functional demands, Mechanical properties at www.ecophon.com. For the Technical tiles installed according to M391 there is a load bearing capacity of 100 N for each Main runner per 1200 mm. This gives a total load bearing capacity of 200 N for a load evenly distributed on two Main runners.



CE

Ecophon ceiling systems are CE marked according to the European harmonized standard EN 13964:2014. CE marked construction products are covered by a Declaration of Performance (DOP) which enables customers and users to easily compare performance of products available on the European market.

INSTALLATION DIAGRAM (M278) FOR ECOPHON FOCUS LP

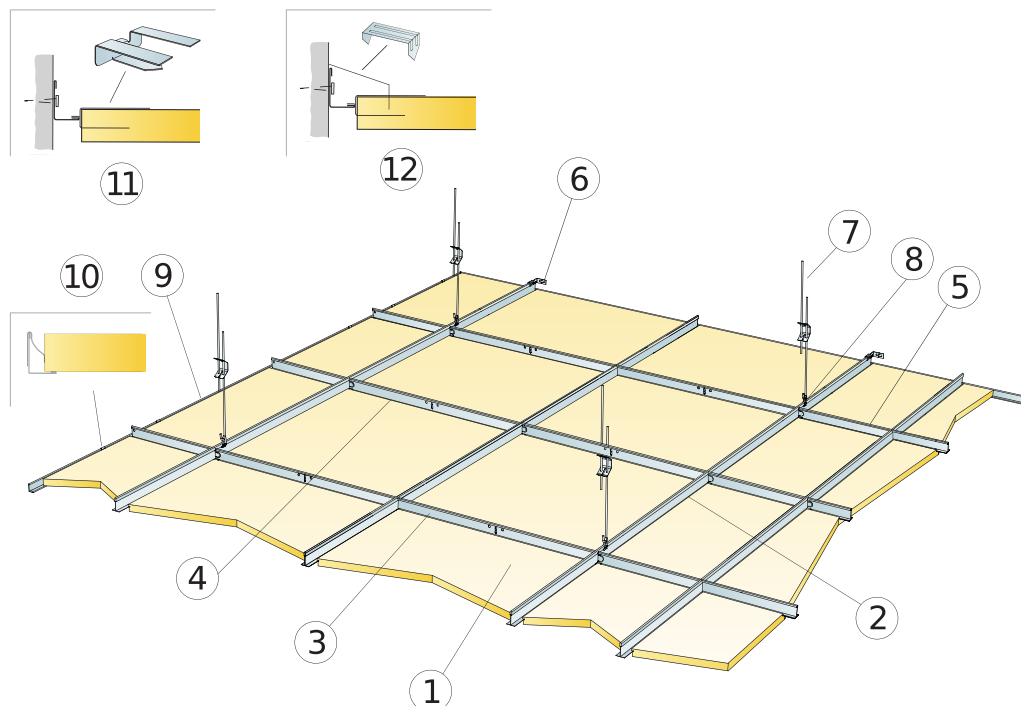

QUANTITY SPECIFICATION (EXCL. WASTAGE)

	Size, mm			
	600x300	600x600	1200x300	1200x600
1 Focus Ip	5,6/m ²	2,8/m ²	2,8/m ²	1,4/m ²
2 Connect T24 Main runner, installed at 1200 mm centres (max distance from wall 600 mm)	0,9m/m ²	0,9m/m ²	0,9m/m ²	0,9m/m ²
3 Connect T24 Cross tee L=1200 mm	3,4m/m ²	1,7m/m ²	3,4m/m ²	1,7m/m ²
4 Connect T24 Cross tee, L=600 mm	-	0,9m/m ²	-	-
5 Connect T24 Cross tee, L=300 mm	0,9m/m ²	-	-	-
6 Connect Wall Bracket for T-profiles	1/suspended row of Main runner			
7 Connect Adjustable Hanger, installed at 1200 mm centres (max. distance from wall 600 mm)	0,7/m ²	0,7/m ²	0,7/m ²	0,7/m ²
8 Connect Hanger Clip (not to be used in swimming hall environments)	0,7/m ²	0,7/m ²	0,7/m ²	0,7/m ²
9 Connect Angle trim, fixed at 300 mm centres	as required	as required	as required	as required
10 Connect Wall spring	2 pcs/on every cut perimeter tile with only 1 supporting edge			
11 Connect Support clip Dg20	2per perimeter tile, cut on the long side	2per perimeter tile, cut on the long side	3per perimeter tile, cut on the long side	3per perimeter tile, cut on the long side
12 Connect Perimeter tile clip	1/300-400mm on any cut edge			
Δ Min. overall depth of system: 115 mm	-	-	-	-
δ Min. demounting depth: 20 mm	-	-	-	-
For luminaire integration in panels use Connect Bridging	-	-	-	-

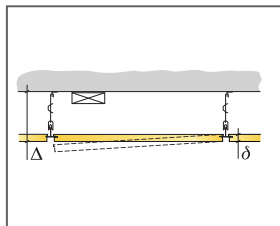

See Quantity specification

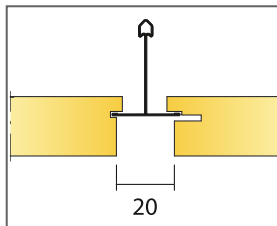

Distance between Focus Ip tiles

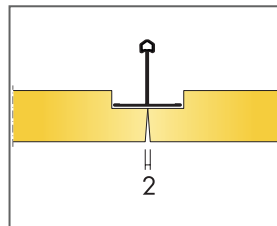

Non-supported edges meeting with space for cross-tee.

Size, mm	Max live load (N)	Min load bearing capacity (N)
600x300	30	160
600x600	30	160
1200x300	30	160
1200x600	30	160

Live load/load bearing capacity

INSTALLATION DIAGRAM (M279) FOR ECOPHON FOCUS LP TECHNICAL TILE

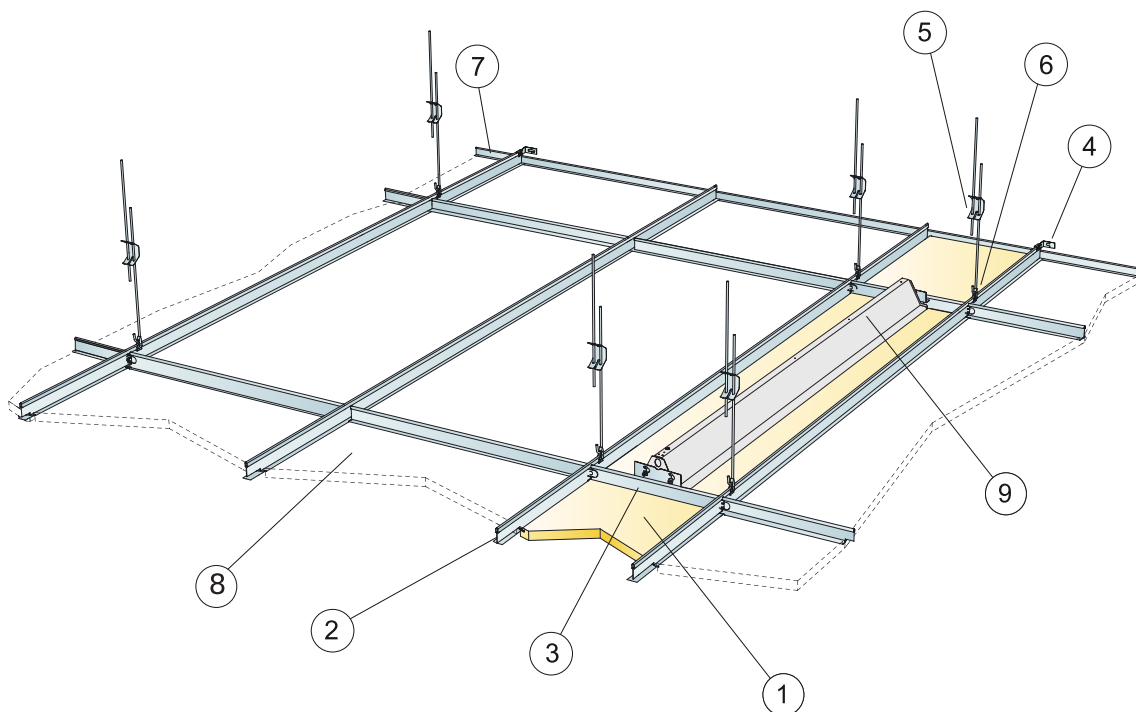

QUANTITY SPECIFICATION (EXCL. WASTAGE)

	Size, mm					
	600x150	600x300	600x600	1200x150	1200x300	1200x600
1 Focus Ip Technical tile	11,1/m ²	5,6/m ²	2,8/m ²	5,6/m ²	2,8/m ²	1,4/m ²
2 Connect T24 Main runner	6,7m/m ²	3,35m/m ²	1,7m/m ²	6,7m/m ²	3,35m/m ²	1,7m/m ²
3 Connect T24 Cross tee, L=150/300/600 mm	1,7m/m ²	1,7m/m ²	1,7m/m ²	0,85m/m ²	0,85m/m ²	0,85m/m ²
4 Connect Wall Bracket for T-profiles	1/suspended row of Main runner					
5 Connect Adjustable hanger, installed at 1200 mm centres (max. distance from wall 600 mm)	5,6/m ²	2,8/m ²	1,4/m ²	5,6/m ²	2,8/m ²	1,4/m ²
6 Connect Hanger clip	5,6/m ²	2,8/m ²	1,4/m ²	5,6/m ²	2,8/m ²	1,4/m ²
7 Connect Angle trim, fixed at 300 mm centres	as required	as required	as required	as required	as required	as required
8 Focus Ip (adjacent ceiling)	-	-	-	-	-	-
9 Ecophon Line Ip	-	-	-	-	-	-
Δ Min. overall depth of system: 105 mm (190 mm when using Connect Space bar connector)	-	-	-	-	-	-
δ Min. demounting depth: 20 mm	-	-	-	-	-	-
For luminaire integration in panels use Connect Bridging	-	-	-	-	-	-
The area in quantity specification for M279 refers to the installation area between the two suspended Main runners. Maximum two rows of Technical tiles can be installed next to each other.	-	-	-	-	-	-
For integration with a unbroken luminaire, width smaller than 300 mm use Connect Spacebar connector, max height 75 mm	-	-	-	-	-	-

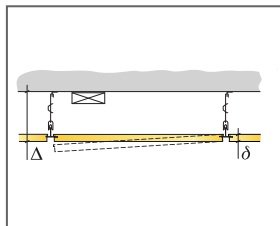

See Quantity specification

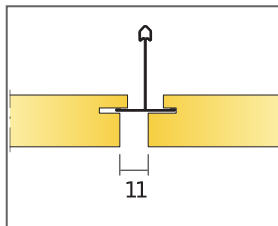

Distance between Focus Ip and Focus Ip Technical tile

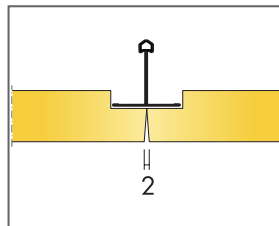

Non-supported edges meeting with space for cross-tee.

Size, mm	Max live load (N)	Min load bearing capacity (N)
600x150	50	160
600x300	50	160
600x600	50	160
1200x150	50	160
1200x300	50	160
1200x600	50	160

Live load/load bearing capacity

INSTALLATION DIAGRAM (M278) FOR ECOPHON FOCUS LP XL

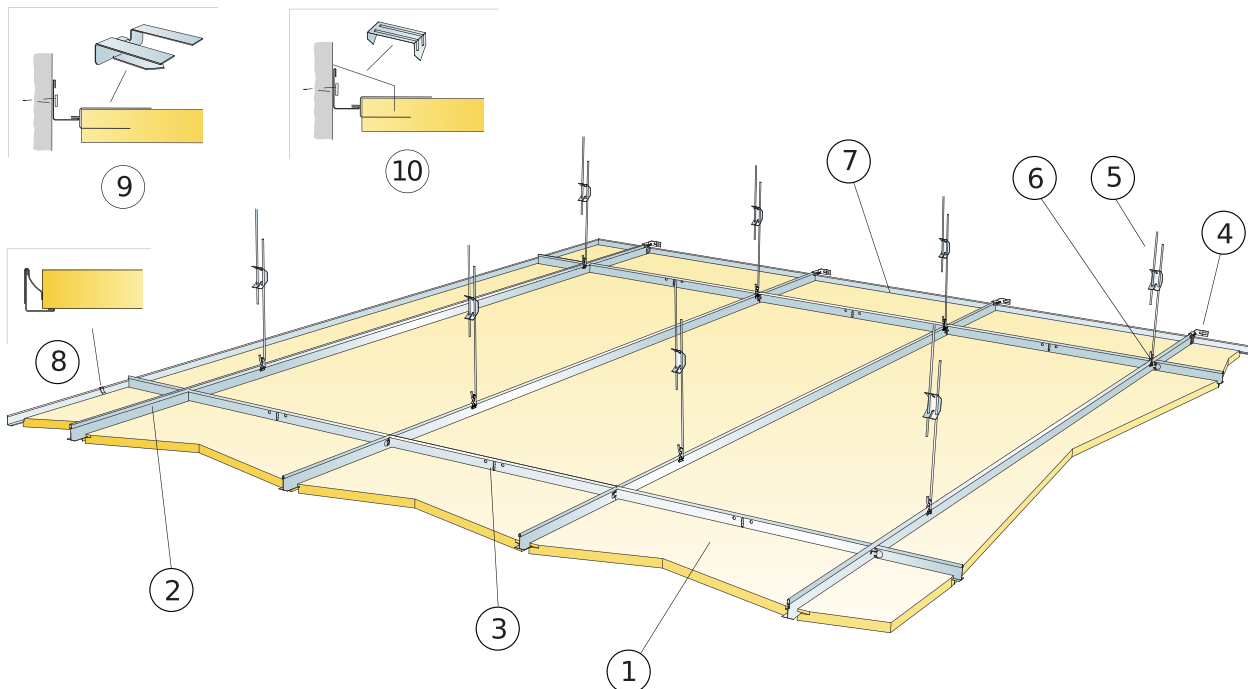

QUANTITY SPECIFICATION (EXCL. WASTAGE)

	Size, mm
	1800x600
1 Focus Lp	0,95/m ²
2 Connect T24 Main runner, installed at 600 mm centres	1,7m/m ²
3 Connect T24 Cross tee, L=600 mm	0,6m/m ²
4 Connect Wall Bracket for T-profiles	1/suspended row of Main runner
5 Connect Adjustable hanger, installed at 1500 mm centres (max. distance from wall 450 mm)	1,1/m ²
6 Connect Hanger Clip (not to be used in swimming hall environments)	0,7/m ²
7 Connect Angle trim, fixed at 300 mm centres	as required
8 Connect Wall spring	3pcs/on every cut perimeter tile with only 1 supporting edge
9 Connect Support clip Dg20	4per perimeter tile, cut on the long side
10 Connect Perimeter tile clip	1/300-400mm on any cut edge
Δ Min. overall depth of system: 115 mm	-
δ Min. demounting depth: 20 mm	-
For luminaire integration in panels use Connect Bridging	-

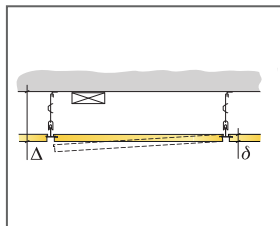

See Quantity specification

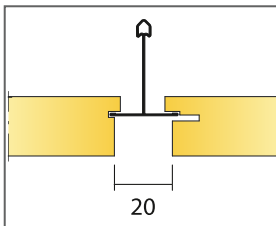

Distance between Focus Lp tiles

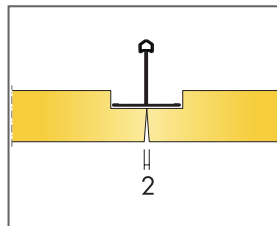

Non-supported edges meeting with space for cross-tee.

Size, mm	Max live load (N)	Min load bearing capacity (N)
1800x600	50	160

Live load/load bearing capacity

Ecophon Focus™ SQ

Ecophon Focus™ SQ bonds directly to the soffit surface. Tiles are installed with a gap between each tile, creating a ceiling with a smooth appearance. For applications where the minimum possible overall depth of system is required due to limited space or other reason.



SYSTEM RANGE



Size, mm	600x600	1200x600
Direct	•	•
Thickness (THK)	20	20
Inst. Diagr.	M107	M107

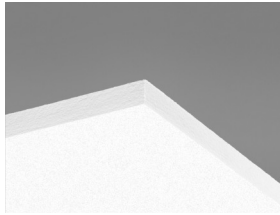

Focus SQ tile

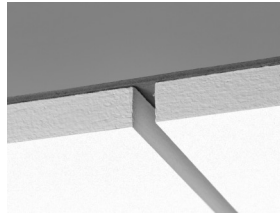

Section of Focus SQ system

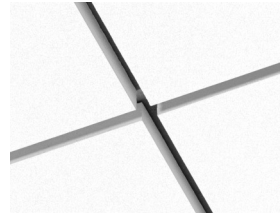

Focus SQ system



Acoustic

Sound Absorption:

Test results according to EN ISO 354. Classification according to EN ISO 11654, and the single value ratings for Noise Reduction Coefficient, NRC and Sound Absorption Average, SAA according to ASTM C 423.

α_p , Practical sound absorption coefficient

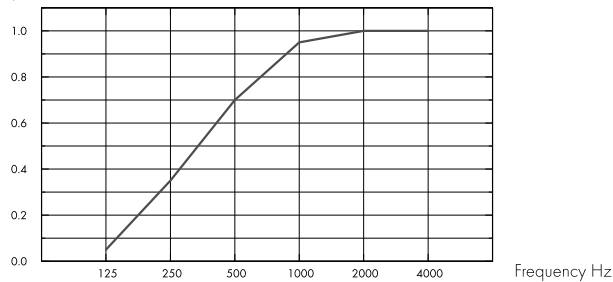

– Focus SQ 20 mm, 20 mm o.d.s.

THK mm	o.d.s. mm	α_p , Practical sound absorption coefficient						α_w	Sound absorption class
		125 Hz	250 Hz	500 Hz	1000 Hz	2000 Hz	4000 Hz		
20	20	0.05	0.35	0.70	0.95	1.00	1.00	0.65	C

THK mm	AC(1.5)
20	Articulation Class, ASTM E1111, ASTM E1110 190



Indoor Air Quality

Certificate / Label	Standard	Plant
Eurofins Indoor Air Comfort®	IAC	IAC Gold
French VOC	A	A+
Finnish M1	•	•



Environmental Footprint

	Kg CO ₂ equiv/m ²
Focus SQ	4,88 (Focus family EPD in conformity with ISO 14025 / EN 15804)
Focus SQ/Plant	2,76 (Focus SQ/Plant EPD in conformity with ISO 14025 / EN 15804)



Circularity

Minimum post-consumer recycled content	57%
Recyclability	Fully recyclable



Fire safety

Country	Standard	Class
Europe	EN 13501-1	A2-s1,d0

The glass wool core of the tiles is tested and classified as non-combustible according to EN ISO 1182.



Humidity Resistance

Product	
Standard	Class C, RH 95% and 30°C
Plant	Class A, RH 70% and 25°C

According to EN 13964:2014



Visual appearance

White Frost, nearest NCS colour sample S 0500-N, 85% light reflectance. Gloss < 1.



Cleanability

Daily dusting and vacuum cleaning. Weekly wet wiping.



Accessibility

The tiles are not demountable.



Installation

Installed according to installation diagrams, installation guides and drawing aid. For information regarding minimum overall depth of system see quantity specification. Rendered surfaces must have sufficient strength to be able to carry the load imposed by the tiles. If doubts, test gluing should be carried out. The surface should always be dry and clean. For best result the surface should be even, however an acceptable result could be achieved on slightly uneven surfaces.



System weight

The weight of the system should be approximately 2,5 kg/m²



Mechanical properties

Additional live load has to be fixed to the soffit.



CE

Ecophon ceiling systems are CE marked according to the European harmonized standard EN 13964:2014. CE marked construction products are covered by a Declaration of Performance (DOP) which enables customers and users to easily compare performance of products available on the European market.

INSTALLATION DIAGRAM (M107) FOR ECOPHON FOCUS SQ, USING CONNECT ABSORBER GLUE

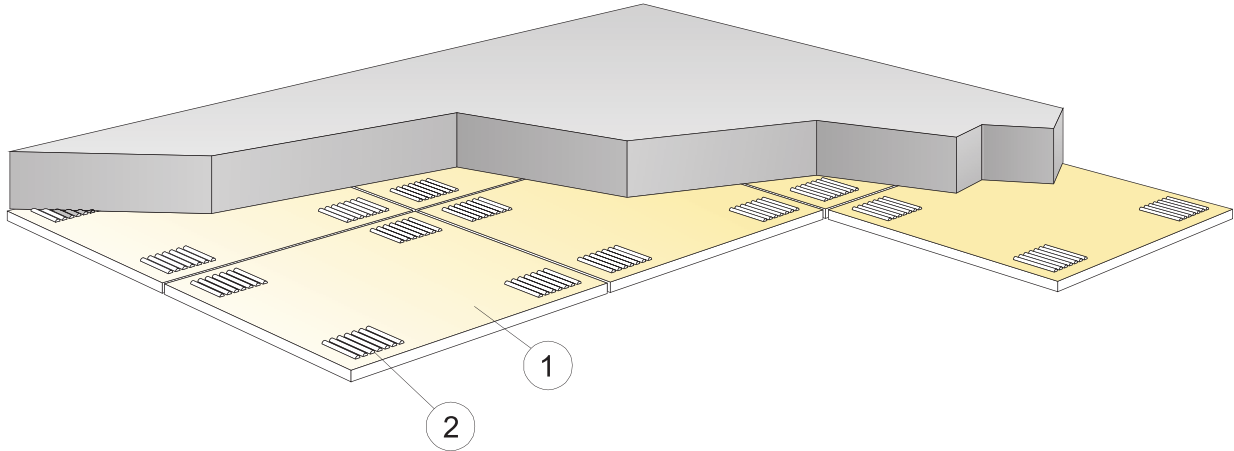

© Ecophon Group

QUANTITY SPECIFICATION (EXCL. WASTAGE)

	Size, mm	
	600x600	1200x600
1 Focus SQ	2,8/m ²	1,4/m ²
2 Connect Absorber glue (0,25 l/m ² - 0,4 l/m ² depending on installation conditions)	as required	as required
Use Connect Notched spatula to apply the glue.	-	-
Δ Min. overall depth of system: 23 mm	-	-
δ Min. demounting depth: The system is not demountable	-	-
Visible edges should be painted	-	-
* Panel Module size 600x600 [592x592], 1200x600 [1192x592]	-	-

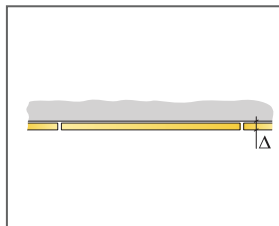

See Quantity specification

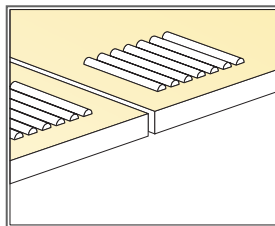

Application of glue

Ecophon Focus™ Flexiform A

Ecophon Focus™ Flexiform A panels are delivered flat and formed on site into concave or convex form by means of special profiles. Ideal for creating surfaces with special curvatures, or if the dimensions of the installations above the suspended ceiling cannot be accommodated.



Miejska Sala Widowiskowo-Sportowa, Kępno, Poland

SYSTEM RANGE

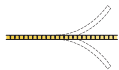

Size, mm	1200x600	1600x600	2000x600	2400x600
T24	•	•	•	•
Thickness (THK)	30	30	30	30
Inst. Diagr.	M31, M31ec, M31ic	M31, M31ec, M31ic	M31, M31ec, M31ic	M31, M31ec, M31ic

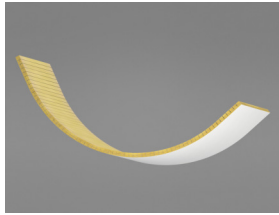

Focus Flexiform A panel

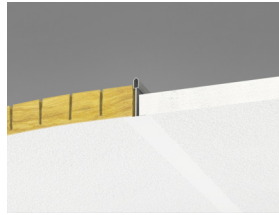

Section of Focus Flexiform A system with Connect T24

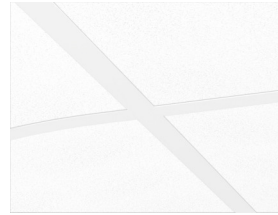

Focus Flexiform A system



Acoustic

Acoustic values corresponding to a flat ceiling.

Sound Absorption:

Test results according to EN ISO 354. Classification according to EN ISO 11654, and the single value ratings for Noise Reduction Coefficient, NRC and Sound Absorption Average, SAA according to ASTM C 423.

α_p , Practical sound absorption coefficient

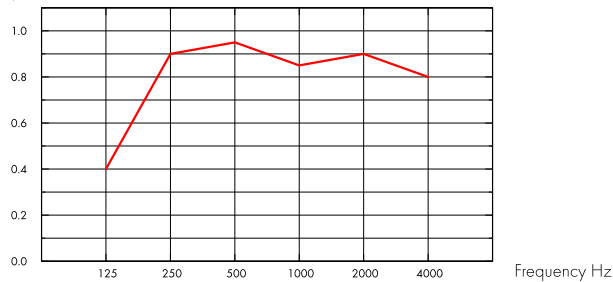

— Focus Flexiform A 30 mm, 200 mm o.d.s.

THK mm	o.d.s. mm	α_p , Practical sound absorption coefficient						α_w	Sound absorption class
		125 Hz	250 Hz	500 Hz	1000 Hz	2000 Hz	4000 Hz		
30	200	0.40	0.90	0.95	0.85	0.90	0.80	0.90	A

THK mm	D_{nfw}		CAC dB	
	Weighted normalized flanking level difference, ISO 10848-2		Ceiling Attenuation Class, ASTM 1414, ASTM E413	
20	24		25	



Indoor Air Quality

Certificate / Label	
Eurofins Indoor Air Comfort®	IAC
French VOC	A
Finnish M1	•



Environmental Footprint

Kg CO ₂ equiv/m ²	
Focus Flexiform A	3,1 (Focus family EPD in conformity with ISO 14025 / EN 15804)



Circularity

Minimum post-consumer recycled content	39%
Recyclability	Fully recyclable



Fire safety

Country	Standard	Class
Europe	EN 13501-1	A2-s1,d0

The glass wool core of the tiles is tested and classified as non-combustible according to EN ISO 1182.



Humidity Resistance

Class C, relative humidity 95% and 30°C, according to EN 13964:2014



Visual appearance

White Frost, nearest NCS colour sample S 0500-N, 85% light reflectance. Gloss < 1.



Cleanability

Daily dusting and vacuum cleaning. Weekly wet wiping.



Accessibility

The tiles are not demountable.



Installation

Installed according to installation diagrams, installation guides and drawing aid. (Please note: Extreme incident light, near windows or other light sources, can create undesired shadow effects on the structured surface on curved installations.)



System weight

The weight is approximately 3 kg/m², depending on the installation method.



Mechanical properties

Additional live load has to be fixed to the soffit.



CE

Ecophon ceiling systems are CE marked according to the European harmonized standard EN 13964:2014. CE marked construction products are covered by a Declaration of Performance (DOP) which enables customers and users to easily compare performance of products available on the European market.

INSTALLATION DIAGRAM (M31) FOR ECOPHON FOCUS FLEXIFORM A

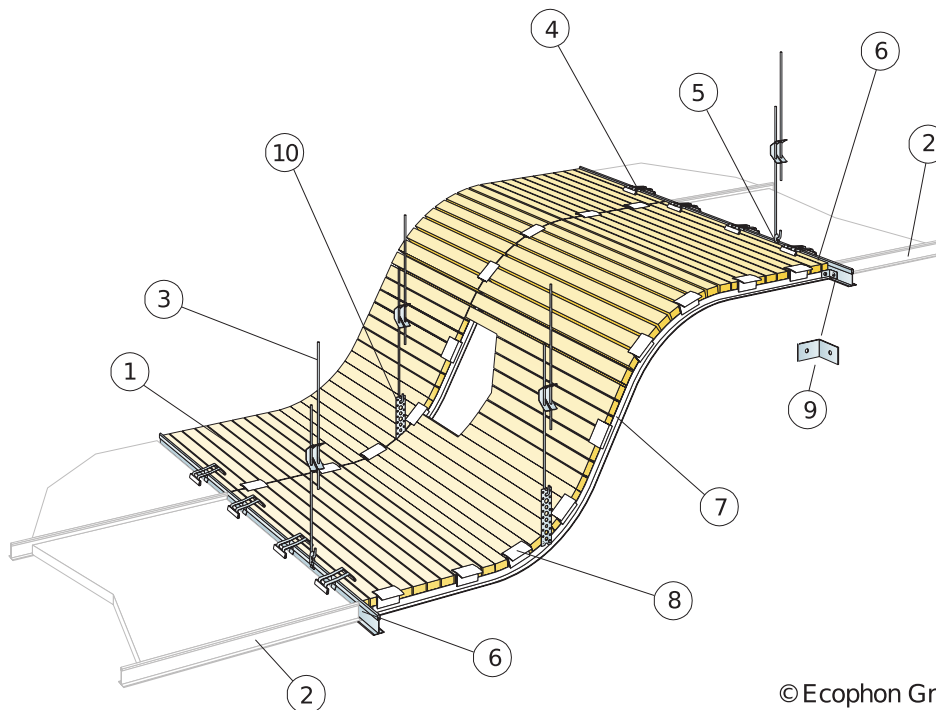

© Ecophon Group

QUANTITY SPECIFICATION (EXCL. WASTAGE)

	Size, mm			
	1200x600	1600x600	2000x600	2400x600
1 Focus Flexiform A	as required	as required	as required	as required
2 Connect T24 Cross tee (adjacent ceiling)	as required	as required	as required	as required
3 Connect Adjustable hanger, installed at 1200 mm centres	as required	as required	as required	as required
4 Connect Clip 100/20	as required	as required	as required	as required
5 Connect Hanger clip	as required	as required	as required	as required
6 Connect T24 Main runner	1,8m/m ²	-	-	-
7 Connect Flexiform profile/Flexible Flexiform profile, installed at 600 mm centres.	as required	as required	as required	as required
8 Connect Flexiform clip, fixed at 100-300 mm (depending on the radius of curve)	as required	as required	as required	as required
9 Connect Angle bracket	as required	as required	as required	as required
10 Perforated strip (not supplied by Ecophon)	as required	as required	as required	as required
Flexiform profile: Radius of curve (concave or convex) min 200 mm.	-	-	-	-
Length of flexiform profile: max 2400 mm. When Flexiform profiles are longer than 1 m, intermediate suspensions are required.	-	-	-	-

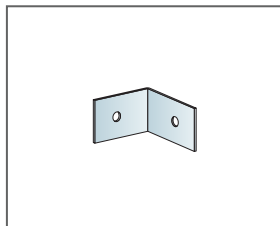

Connect Angle bracket

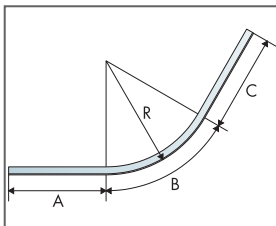

Example with dimensions of Flexiform profile

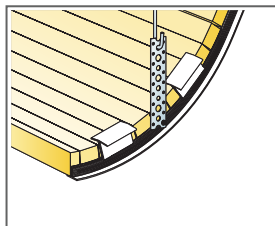

Suspension with metal strip

INSTALLATION DIAGRAM (M31EC) FOR ECOPHON FOCUS FLEXIFORM A EXTERNAL CORNER

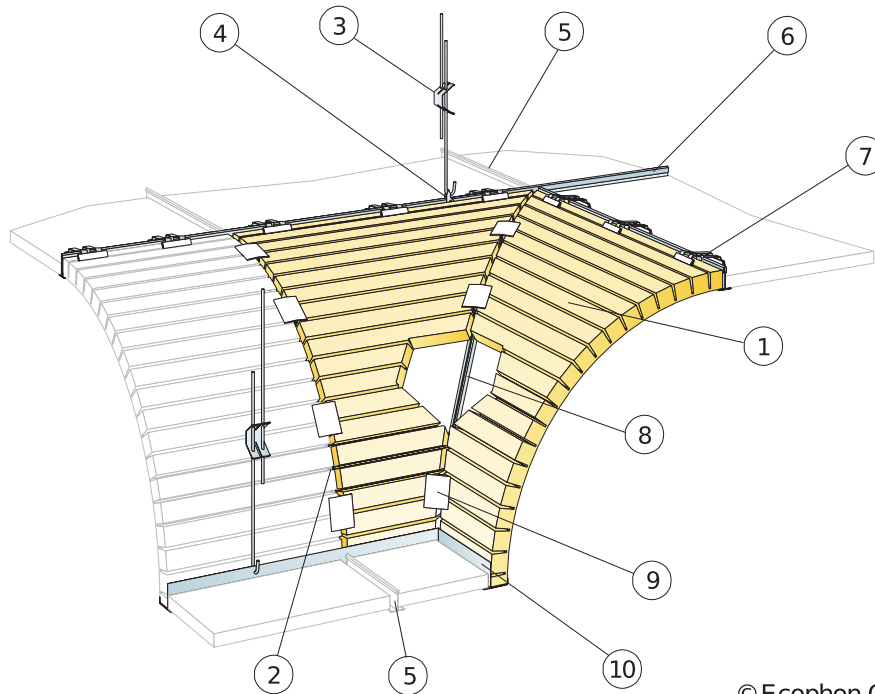

© Ecophon Group

QUANTITY SPECIFICATION (EXCL. WASTAGE)

	Size, mm			
	1200x600	1600x600	2000x600	2400x600
1 Focus Flexiform A	as required	as required	as required	as required
2 Connect Flexiform profile/Flexible Flexiform profile , installed at 600 mm centres.	as required	as required	as required	as required
3 Connect Adjustable hanger, installed at 1200 mm centres	as required	as required	as required	as required
4 Connect Hanger clip	as required	as required	as required	as required
5 Connect T24 Cross tee (adjacent ceiling)	as required	as required	as required	as required
6 Connect T24 Main runner	1,8m/m ²	-	-	-
7 Connect Clip 100/20	as required	as required	as required	as required
8 Connect Flexible external corner profile	as required	as required	as required	as required
9 Connect Flexiform clip, fixed at 100-300 mm (depending on the radius of curve)	as required	as required	as required	as required
10 Connect F-trim F	as required	as required	as required	as required
Flexiform profile: Radius of curve (concave or convex) min 200 mm.	-	-	-	-
Length of flexiform profile: max 2400 mm. When Flexiform profiles are longer than 1 m, intermediate suspensions are required.	-	-	-	-

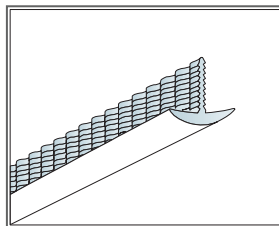

Profile for external corner

INSTALLATION DIAGRAM (M311C) FOR ECOPHON FOCUS FLEXIFORM A INTERNAL CORNER

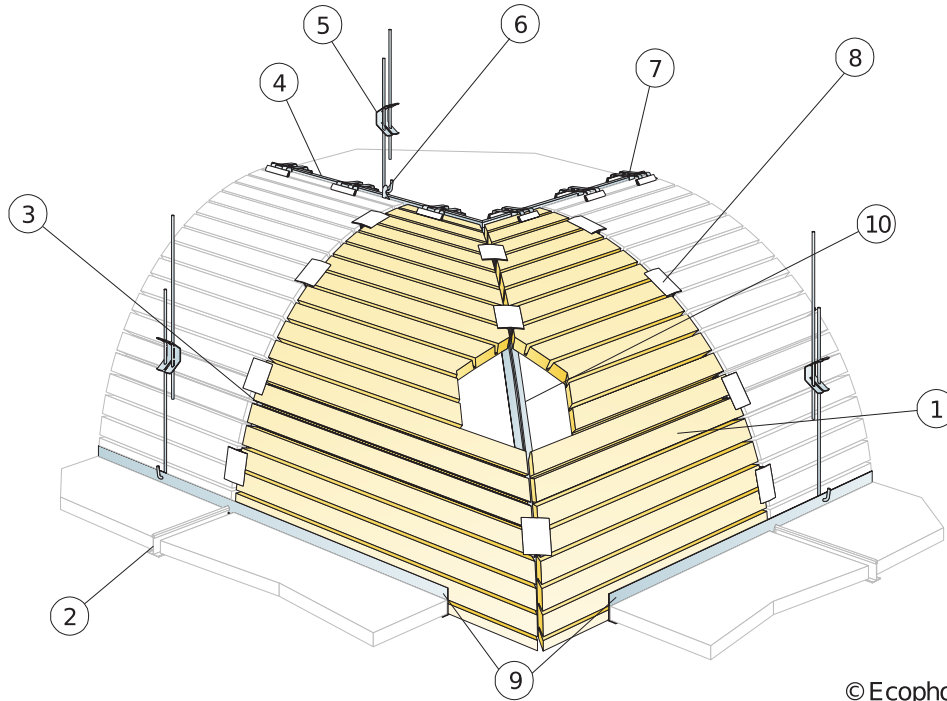

© Ecophon Group

QUANTITY SPECIFICATION (EXCL. WASTAGE)

	Size, mm			
	1200x600	1600x600	2000x600	2400x600
1 Focus Flexiform A	as required	as required	as required	as required
2 Connect T24 Cross tee (adjacent ceiling)	as required	as required	as required	as required
3 Connect Flexiform profile/Flexible Flexiform profile , installed at 600 mm centres.	as required	as required	as required	as required
4 Connect T24 Main runner	1,8m/m ²	-	-	-
5 Connect Adjustable hanger, installed at 1200 mm centres	as required	as required	as required	as required
6 Connect Hanger clip	as required	as required	as required	as required
7 Connect Clip 100/20	as required	as required	as required	as required
8 Connect Flexiform clip, fixed at 100-300 mm (depending on the radius of curve)	as required	as required	as required	as required
9 Connect F-trim F	as required	as required	as required	as required
10 Connect Flexiform profile/Flexible Flexiform profile , installed at 600 mm centres.	as required	as required	as required	as required
Flexiform profile: Radius of curve (concave or convex) min 200 mm.	-	-	-	-
Length of flexiform profile: max 2400 mm. When Flexiform profiles are longer than 1 m, intermediate suspensions are required.	-	-	-	-

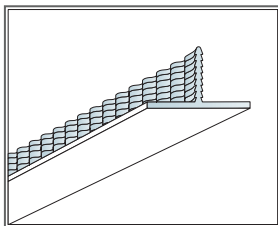

Profile for internal corner

Ecophon Focus™ Fixiform E

Ecophon Focus™ Fixiform E creates distinct transitions between different levels of ceiling to accommodate various ceiling service installations or to add shape and structure to the room. Tiles are delivered flat and folded to 90 degrees on site before installation.

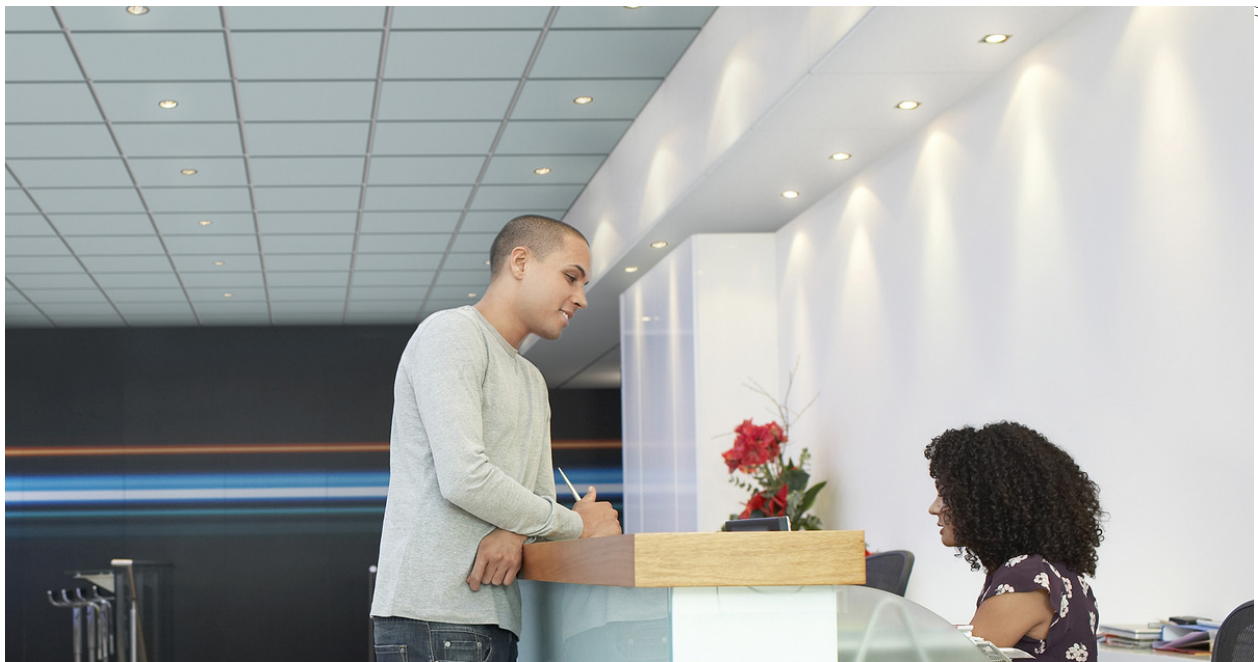

SYSTEM RANGE

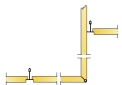

Size, mm	1200x600
T24	•
Thickness (THK)	20
Inst. Diagr.	M276



Focus Fixiform panel

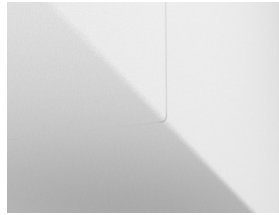

Detail of Focus Fixiform system fold



Focus Fixiform E system



Focus Fixiform E system upper level



Acoustic

Acoustic values corresponding to a flat ceiling.

Sound Absorption:

Test results according to EN ISO 354. Classification according to EN ISO 11654, and the single value ratings for Noise Reduction Coefficient, NRC and Sound Absorption Average, SAA according to ASTM C 423.

α_p , Practical sound absorption coefficient

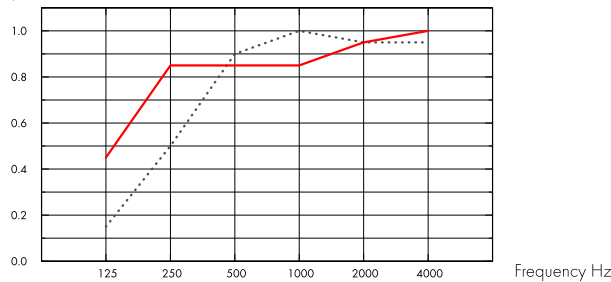

..... Focus Fixiform E 20 mm, 60 mm o.d.s.

— Focus Fixiform E 20 mm, 200 mm o.d.s.

THK mm	o.d.s. mm	α_p , Practical sound absorption coefficient						α_w	Sound absorption class
		125 Hz	250 Hz	500 Hz	1000 Hz	2000 Hz	4000 Hz		
20	60	0.15	0.50	0.90	1.00	0.95	0.95	0.80	B
20	200	0.45	0.85	0.85	0.85	0.95	1.00	0.90	A

THK mm	D_{nfw}		CAC dB	
	Weighted normalized flanking level difference, ISO 10848-2		Ceiling Attenuation Class, ASTM 1414, ASTM E413	
20	24		25	



Indoor Air Quality

Certificate / Label

Eurofins Indoor Air Comfort®	IAC
French VOC	A
Finnish M1	•



Circularity

Minimum post-consumer recycled content	57%
Recyclability	Fully recyclable



Fire safety

Country	Standard	Class
Europe	EN 13501-1	A2-s1,d0

The glass wool core of the tiles is tested and classified as non-combustible according to EN ISO 1182.



Humidity Resistance

Class C, relative humidity 95% and 30°C, according to EN 13964:2014



Visual appearance

White Frost, nearest NCS colour sample S 0500-N, 85% light reflectance. Gloss < 1.



Cleanability

Daily dusting and vacuum cleaning. Weekly wet wiping.



Accessibility

The panels are demountable via adjacent flat ceiling tiles.



Installation

Installed according to installation diagrams, installation guides and drawing aid. Focus Fixiform E is supplied with all necessary installation accessories.



Mechanical properties

Additional live load has to be fixed to the soffit.



CE

Ecophon ceiling systems are CE marked according to the European harmonized standard EN 13964:2014. CE marked construction products are covered by a Declaration of Performance (DOP) which enables customers and users to easily compare performance of products available on the European market.

INSTALLATION DIAGRAM (M276) FOR ECOPHON FOCUS FIXIFORM E

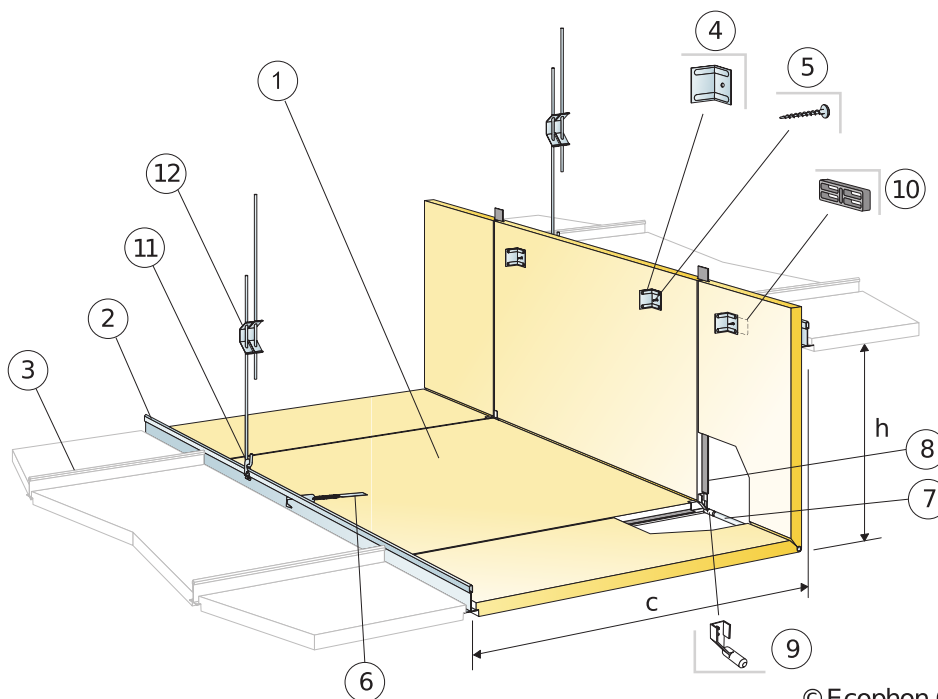

© Ecophon Group

QUANTITY SPECIFICATION (EXCL. WASTAGE)

		Size, mm
		1200x600
1	Focus Fixiform E (kit)	as required
2	Connect T24 Main runner	1,8m/m ²
3	Connect T24 Cross tee (adjacent ceiling)	as required
4	Angle Bracket Fixiform (included in Fixiform kit)	-
5	Absorber screw metal 50 (included in Fixiform kit)	-
6	Connect Hook (included in Fixiform kit)	-
7	Reinforcement rod (included in Fixiform kit)	-
8	Connect F Spline (included in Fixiform kit)	-
9	Plug for reinforcement rod (included in Fixiform kit)	-
10	Distance (included in Fixiform kit)	-
11	Connect Hanger clip	1 pcs/hanger
12	Connect Adjustable hanger, installed at 600 mm centres at the level change	1,4/m ²
Δ Min. overall depth of system: Δ1=160 mm and Δ2=80 mm from upper level		-
δ Min. demounting depth: Individual ceiling tiles are non-demountable		-
Dimension: c=600 mm, h<530 mm		-

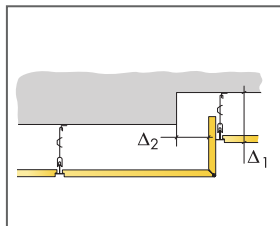

See Quantity specification

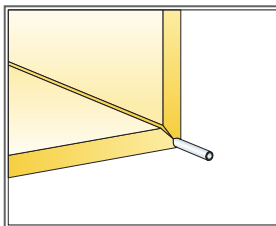

The fold is reinforced by a rod

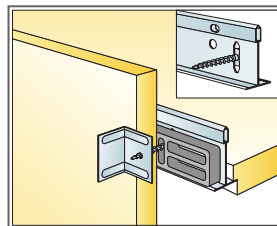

Upper level connection to Main runner

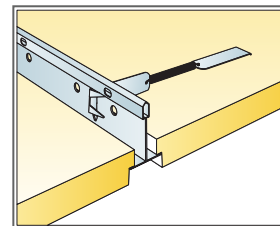

Lower level connection to Main runner

Ecophon Focus™ Fixiform Ds

Ecophon Focus™ Fixiform Ds creates distinct transitions between different ceiling levels to accommodate various ceiling service installations or to offer shape and structure to a room. Tiles are delivered flat and folded to 90 degrees on site before installation.



Ecophon Head Office, Sweden

SYSTEM RANGE

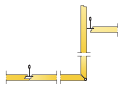

Size, mm	1200x600	XL 1500x600	XL 1900x600	XL 2300x600
T24	•	•	•	•
Thickness (THK)	20	20	20	20
Inst. Diag.	M274	M275	M275	M275



Focus Fixiform panel

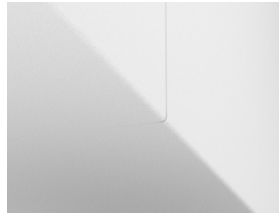

Detail of Focus Fixiform system fold

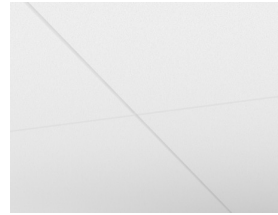

Focus Fixiform Ds system



Focus Fixiform Ds system upper level



Acoustic

Acoustic values corresponding to a flat ceiling.

Sound Absorption:

Test results according to EN ISO 354. Classification according to EN ISO 11654.

α_p , Practical sound absorption coefficient

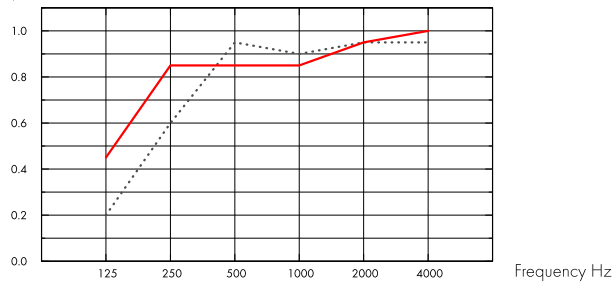

..... Focus Fixiform Ds 20 mm, 75 mm o.d.s.
 — Focus Fixiform Ds 20 mm, 200 mm o.d.s.

THK mm	o.d.s. mm	α_p , Practical sound absorption coefficient						α_w	Sound absorption class
		125 Hz	250 Hz	500 Hz	1000 Hz	2000 Hz	4000 Hz		
20	75	0.20	0.60	0.95	0.90	0.95	0.95	0.90	A
20	200	0.45	0.85	0.85	0.85	0.95	1.00	0.90	A

THK mm	D_{nfw}		CAC dB	
	Weighted normalized flanking level difference, ISO 10848-2		Ceiling Attenuation Class, ASTM 1414, ASTM E413	
20	24		25	



Indoor Air Quality

Certificate / Label	
Eurofins Indoor Air Comfort®	IAC
French VOC	A
Finnish M1	•



Circularity

Minimum post-consumer recycled content	57%
Recyclability	Fully recyclable



Fire safety

Country	Standard	Class
Europe	EN 13501-1	A2-s1,d0

The glass wool core of the tiles is tested and classified as non-combustible according to EN ISO 1182.



Humidity Resistance

Class C, relative humidity 95% and 30°C, according to EN 13964:2014



Visual appearance

White Frost, nearest NCS colour sample S 0500-N, 85% light reflectance. Gloss < 1.



Cleanability

Daily dusting and vacuum cleaning. Weekly wet wiping.



Accessibility

The panels are demountable via adjacent flat ceiling tiles.



Installation

Installed according to installation diagrams, installation guides and drawing aid. Focus Fixiform Ds is supplied with all necessary installation accessories.



Mechanical properties

Additional live load has to be fixed to the soffit.



CE

Ecophon ceiling systems are CE marked according to the European harmonized standard EN 13964:2014. CE marked construction products are covered by a Declaration of Performance (DOP) which enables customers and users to easily compare performance of products available on the European market.

INSTALLATION DIAGRAM (M274) FOR ECOPHON FOCUS FIXIFORM DS

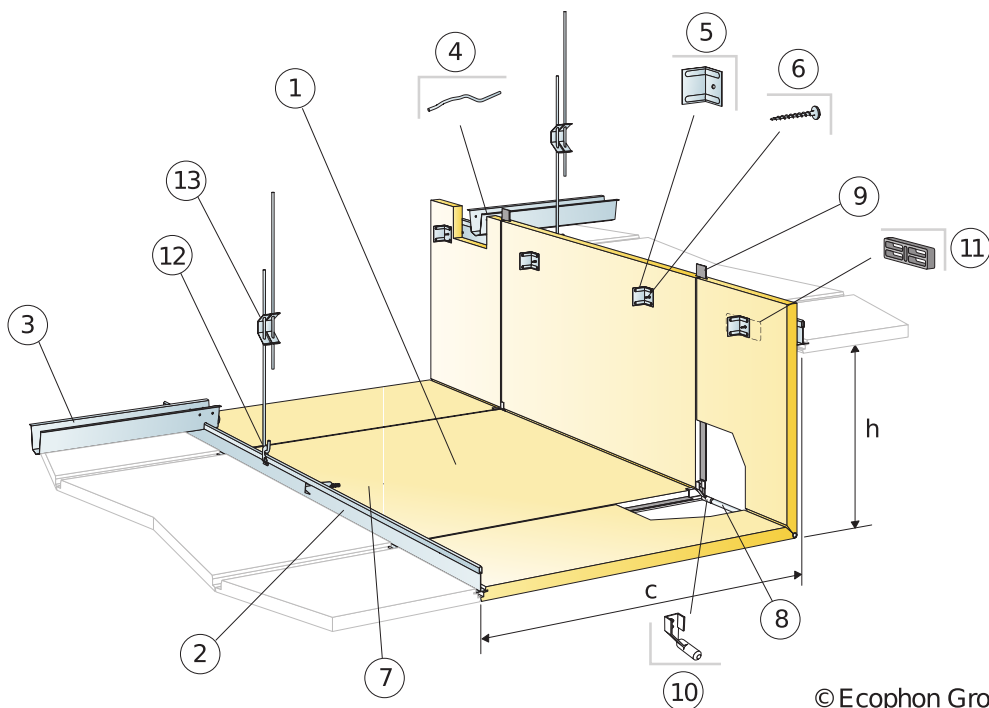

QUANTITY SPECIFICATION (EXCL. WASTAGE)

		Size, mm
		1200x600
1	Focus Fixiform Ds (kit)	as required
2	Connect T24 Main runner HD	as required
3	Connect Space bar, installed at 1500 mm centres (max. distance from wall 300 mm)	as required
4	Connect Space bar winch, installed one per joint Main runner/Space bar	as required
5	Angle Bracket Fixiform (included in Fixiform kit)	-
6	Absorber screw metal 50 (included in Fixiform kit)	-
7	Connect Hook (included in Fixiform kit)	-
8	Reinforcement rod (included)	-
9	Connect F Spline (included in Fixiform kit)	-
10	Plug for reinforcement rod (included)	-
11	Distance (included in Fixiform kit)	-
12	Connect Hanger clip	1 pcs/hanger
13	Connect Adjustable hanger, installed at 600 mm centres at the level change	1,4/m ²
Δ Min. overall depth of system: Δ1=165 mm and Δ2=80 mm from upper level		-
δ Min. demounting depth: Individual ceiling tiles are non-demountable		-
Dimension: c=600 mm, h<530 mm		-

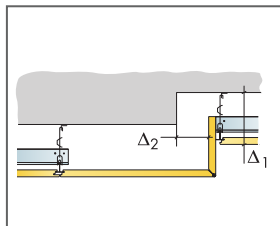

See Quantity specification

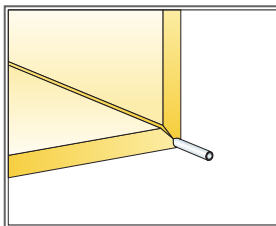

The fold is reinforced by a rod

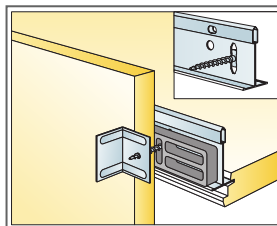

Upper level connection to Main runner

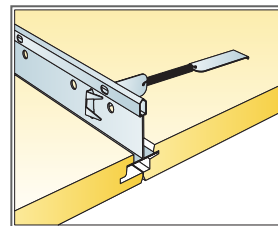

Lower level connection to Main runner

INSTALLATION DIAGRAM (M275) FOR ECOPHON FOCUS FIXIFORM DS XL

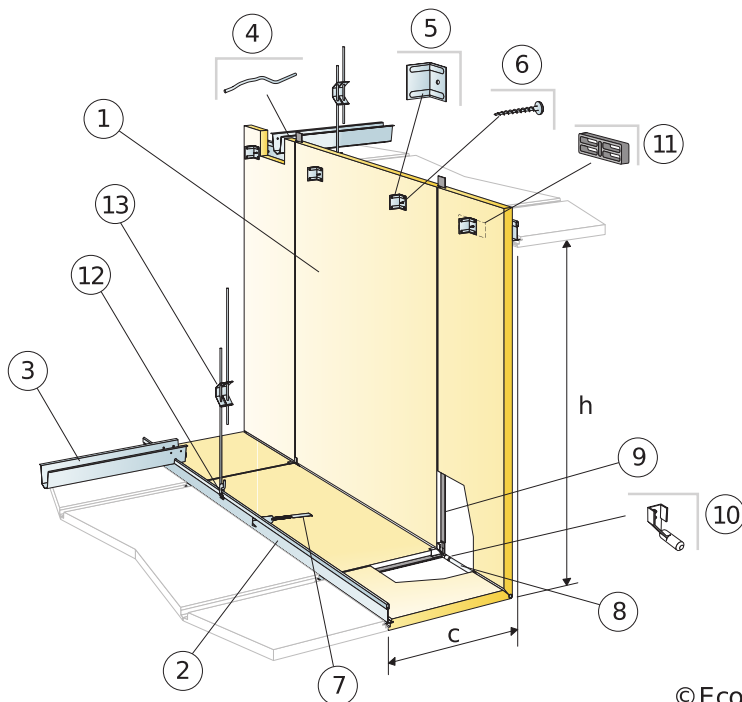

© Ecophon Group

QUANTITY SPECIFICATION (EXCL. WASTAGE)

	Size, mm		
	1500x600	1900x600	2300x600
1 Focus Fixiform Ds XL (kit)	as required	as required	as required
2 Connect T24 Main runner HD	as required	as required	as required
3 Connect Space bar, installed at 1500 mm centres (max. distance from wall 300 mm)	as required	as required	as required
4 Connect Space bar winch, installed one per joint Main runner/Space bar	as required	as required	as required
5 Angle Bracket Fixiform (included in Fixiform kit)	-	-	-
6 Absorber screw metal 50 (included in Fixiform kit)	-	-	-
7 Connect Hook (included in Fixiform kit)	-	-	-
8 Reinforcement rod (included in Fixiform kit)	-	-	-
9 Connect F Spline (included in Fixiform kit)	-	-	-
10 Plug for reinforcement rod (included in Fixiform kit)	-	-	-
11 Distance (included in Fixiform kit)	-	-	-
12 Connect Hanger clip	1 pcs/hanger	1 pcs/hanger	1 pcs/hanger
13 Connect Adjustable hanger, installed at 600 mm centres at the level change	1,4/m ²	1,4/m ²	1,4/m ²
Δ Min. overall depth of system: Δ1=165 mm and Δ2=80 mm from upper level	-	-	-
δ Min. demounting depth: Individual ceiling tiles are non-demountable	-	-	-
Dimension: c=300 mm, h<1130 mm (XL 1500), h<1530 mm (XL 1900), h<1930 mm (XL 2300)	-	-	-

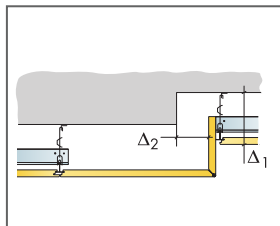

See Quantity specification

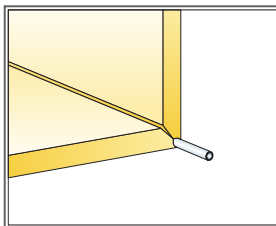

The fold is reinforced by a rod

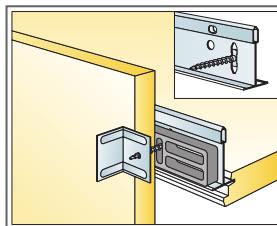

Upper level connection to Main runner

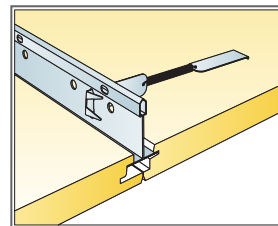

Lower level connection to Main runner

Ecophon Focus™ Frieze

Ecophon Focus™ Frieze is available for edge Dg, Ds, A and E. The frieze can be connected to the wall without any visible trims. For applications where a smooth continuous transition between ceiling and wall is needed.



SYSTEM RANGE

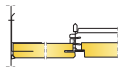

Size, mm	2400x600
T24	•
Thickness (THK)	20
Inst. Diag.	M110, M239

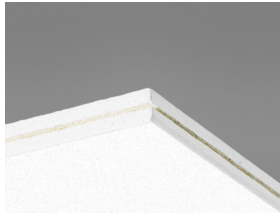

Focus frieze panel

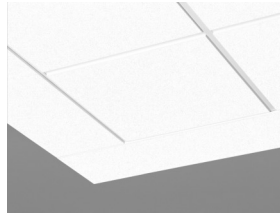

Focus frieze system



Acoustic

Sound Absorption:

Test results according to EN ISO 354. Classification according to EN ISO 11654, and the single value ratings for Noise Reduction Coefficient, NRC and Sound Absorption Average, SAA according to ASTM C 423.

α_p , Practical sound absorption coefficient

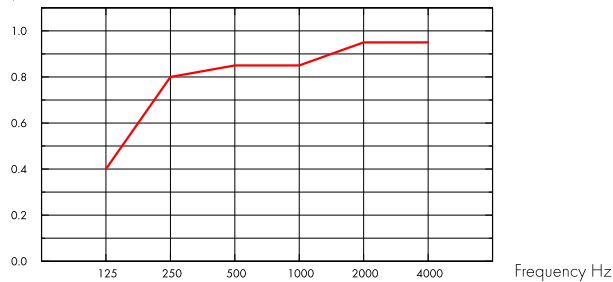

— Focus Frieze E 20 mm, 200 mm o.d.s.

THK mm	o.d.s. mm	α_p , Practical sound absorption coefficient						α_w	Sound absorption class
		125 Hz	250 Hz	500 Hz	1000 Hz	2000 Hz	4000 Hz		
20	200	0.40	0.80	0.85	0.85	0.95	0.95	0.90	A

THK mm	AC(1.5)	D_{nfw}	CAC dB
	Articulation Class, ASTM E1111, ASTM E1110	Weighted normalized flanking level difference, ISO 10848-2	Ceiling Attenuation Class, ASTM 1414, ASTM E413
20	190	24	25



Indoor Air Quality

Certificate / Label	
Eurofins Indoor Air Comfort®	IAC
French VOC	A
Finnish M1	•



Circularity

Minimum post-consumer recycled content	59%
Recyclability	Fully recyclable



Fire safety

Country	Standard	Class
Europe	EN 13501-1	A2-s1,d0

The glass wool core of the tiles is tested and classified as non-combustible according to EN ISO 1182.



Humidity Resistance

Class C, relative humidity 95% and 30°C, according to EN 13964:2014



Visual appearance

White Frost, nearest NCS colour sample S 0500-N, 85% light reflectance. Gloss < 1.



Cleanability

Daily dusting and vacuum cleaning. Weekly wet wiping.



Accessibility

The tiles are not demountable.



Installation

Installed according to installation diagrams, installation guides and drawing aid. For information regarding minimum overall depth of system see quantity specification.



System weight

The system consists of Ecophon Focus™ frieze tiles and Connect™ grid systems, with an approximate weight of 3 kg/m².



Mechanical properties

See table about Max live load and Min load bearing capacity and Functional demands, Mechanical properties at www.ecophon.com.



CE

Ecophon ceiling systems are CE marked according to the European harmonized standard EN 13964:2014. CE marked construction products are covered by a Declaration of Performance (DOP) which enables customers and users to easily compare performance of products available on the European market.

INSTALLATION DIAGRAM (M110) FOR ECOPHON FOCUS FRIEZE A/E

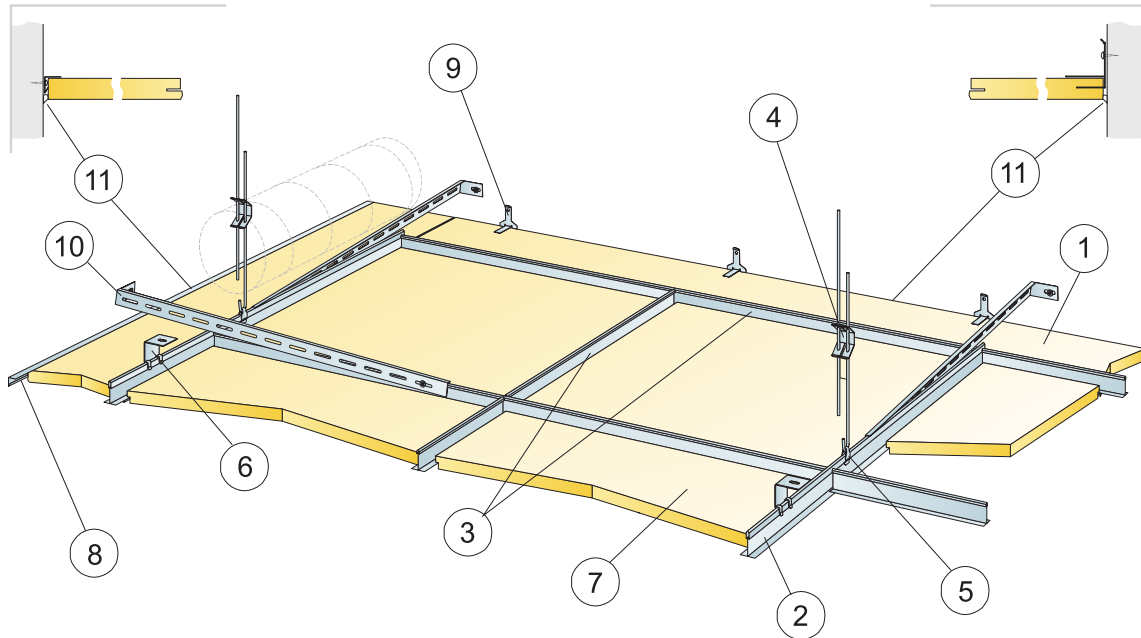

© Ecophon Group

QUANTITY SPECIFICATION (EXCL. WASTAGE)

	Size, mm
	2400x600
1 Focus Frieze	as required
2 Connect T24 Main runner	-
3 Connect T24 Cross tee, L=600 mm	as required
4 Connect Adjustable hanger, installed at 1200 mm centres	as required
5 Connect Hanger clip	as required
6 Connect Direct bracket (only in combination with Frieze trim)	as required
7 Focus A or E, Master A or E	as required
8 Connect Frieze trim, fixed at 300 mm centres. If this solution is used on two opposite walls, the inner part of the ceiling needs to be stabilized towards the walls. Minimum free depth above tile 0 mm.	as required
9 Connect Frieze bracket, installed at 500 mm centre. Minimum free depth above tile 150 mm.	as required
10 Connect Wall bracket, L=700 mm, for space bar	as required
11 Acrylic sealant, [not supplied by Ecophon]	as required
Δ Min. overall depth of system: with Adjustable hanger: 110 mm, with Direct bracket: 60 mm	-
δ Min. demounting depth: The system is not demountable	-
Focus Frieze: Min. overall depth of system: 160 mm	-
Focus Frieze: Min. demounting depth: The system is non-demountable	-
Ecophon Focus frieze: can be divided in two parts if width is less than 300 mm	-

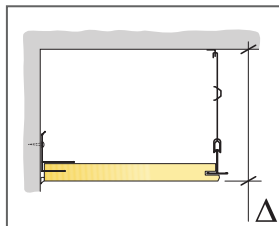

See Quantity specification

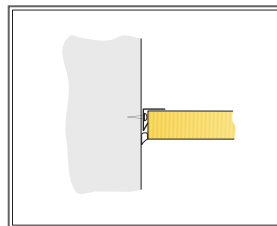

Fixing with frieze trim

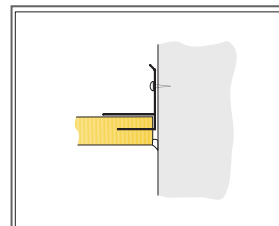

Fixing with frieze bracket

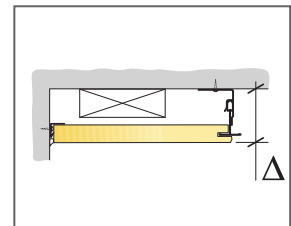

See Quantity specification

INSTALLATION DIAGRAM (M239) FOR ECOPHON FOCUS FRIEZE DS/DG

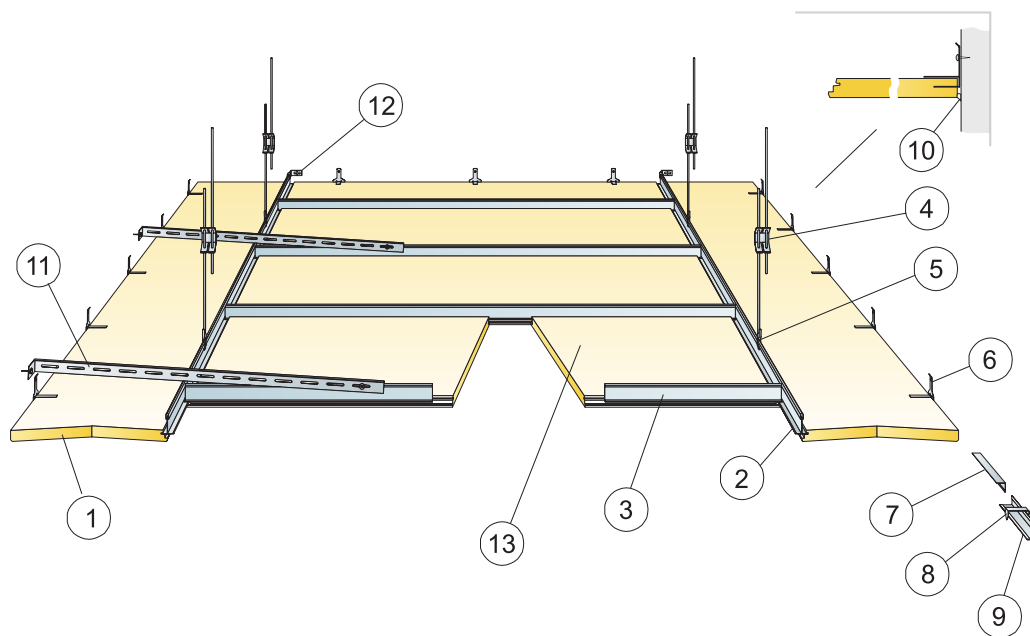

© Ecophon Group

QUANTITY SPECIFICATION (EXCL. WASTAGE)

	Size, mm
	2400x600
1 Focus frieze Ds/Dg	as required
2 Connect T24 Main runner	-
3 Connect T24 Cross Tee L=600/1200/1800 alt. Main runner	as required
4 Connect Adjustable hanger, installed at 1200 mm centres	as required
5 Connect Hanger clip	as required
6 Connect Frieze bracket, installed at 500 mm centre. Minimum free depth above tile 150 mm.	as required
7 Connect Frieze trim, fixed at 300 mm centres.	as required
8 Connect Perimeter tile clip	1/300.400mm on any cut edge
9 Connect Angle trim	as required
10 Acrylic sealant, [not supplied by Ecophon]	as required
11 Connect Wall bracket, L=700 mm, for space bar	as required
12 Connect Wall bracket for T-profiles	as required
13 Focus Ds or Dg	as required
Δ Min. overall depth of system: 110 mm	-
δ Min. demounting depth: Focus frieze tiles are non-demountable, center part according to each system	-
Ecophon Focus frieze: can be divided in two parts if width is less than 300 mm	-

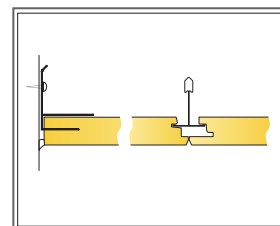
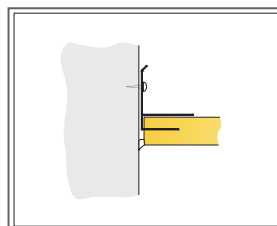
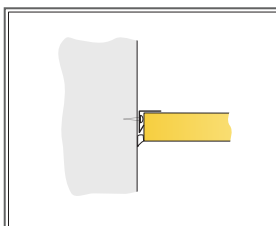
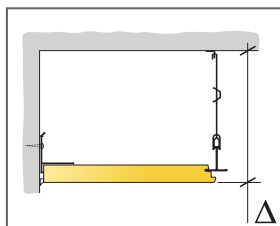

Ecophon Focus Edge™ 500

Ecophon Focus Edge™ 500 is a system used as free hanging unit(s) in applications where the installation of a wall-to-wall ceiling is not possible. The system consists of profiles and corners which together form a well designed perimeter trim.



Piet Hein Building, Netherlands

SYSTEM RANGE

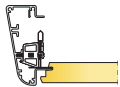

Size, mm	600x600	1200x600	1200x1200	1200x1200
T24	•	•	•	•
Thickness (THK)	20	20	20	25
Inst. Diagr.	M165, M210, M211	M165, M210, M211	M165	M211

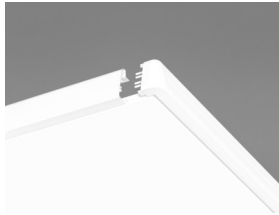

Connect Edge 500 in position for Focus E installation



Acoustic

Ecophon Focus Edge 500 is a perimeter component. For acoustic data on the system - please see corresponding ceiling system (Focus Ds, Focus Dg or Focus/Master E).



Circularity

Fully recyclable.



Fire safety

Country	Standard	Class
Europe	EN 13501-1	A1



Installation

Installed according to installation diagrams, installation guides and drawing aid. For information regarding minimum overall depth of system see quantity specification.



Mechanical properties

Additional live load has to be fixed to the soffit.



CE

Ecophon ceiling systems are CE marked according to the European harmonized standard EN 13964:2014. CE marked construction products are covered by a Declaration of Performance (DOP) which enables customers and users to easily compare performance of products available on the European market.

INSTALLATION DIAGRAM (M165) FOR ECOPHON EDGE 500 WITH FOCUS E T24

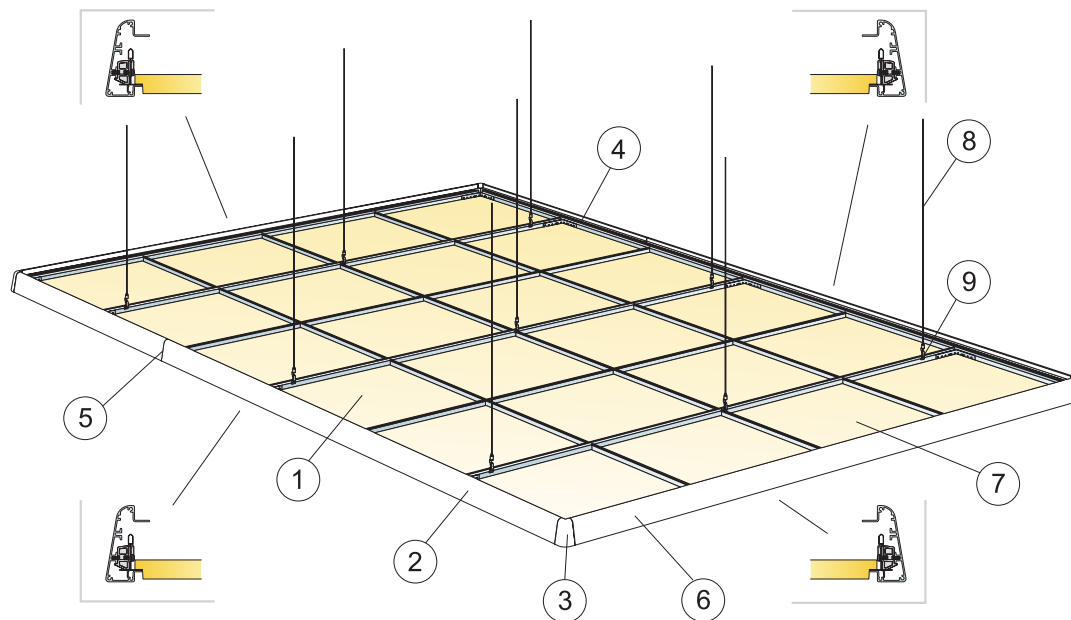

© Ecophon Group

QUANTITY SPECIFICATION (EXCL. WASTAGE)

	Size, mm		
	600x600	1200x600	1200x1200
1 Focus E	2,8/m ²	1,4/m ²	0,7/m ²
2 Connect Edge 500 Profile	as required	as required	as required
3 Connect Edge Corner	as required	as required	as required
4 Connect L-coupling	as required	as required	as required
5 Joint with Guide pins and Joint fixing bracket, (see Edge kit for further details)	as required	as required	as required
6 Connect Edge profile clip E, (18 pcs/kit included in Connect Edge kit E)	as required	as required	as required
7 Focus E tile and Connect grid	as required	as required	as required
8 Connect Adjustable wire hanger, installed at 1200 mm centres	as required	as required	as required
9 Connect Hanger clip	as required	as required	as required
Δ Min. overall depth of system: 130 mm	-	-	-
δ Min. demounting depth: See Focus/Master E	-	-	-
Connect Edge kit E consists of the following components:	-	-	-
18 pcs Connect Edge profile clip with screw RTK 3,5x19, 4 pcs Joint fixing bracket, 1 pc socket screw wrench 2 mm, 1 pc socket screw wrench T10, 12 pcs guide pins, 24 pcs screws RTK ST 3,5x9,5 (for fixing to extrusion), 1 pc installation guide	-	-	-
Not included in kit: Connect L-coupling	-	-	-
Not included in kit: Connect Installation screw BR for L-coupling	-	-	-

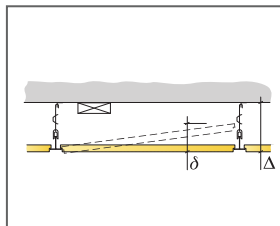

See Quantity specification

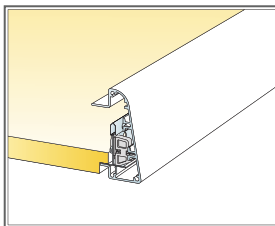

Joint between tile and Edge profile

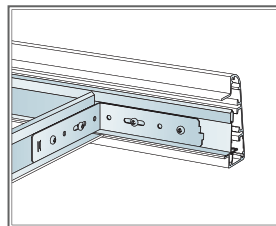

Connection between T-profile and Edge extrusion

Size, mm	Max live load (N)	Min load bearing capacity (N)
600x600	50	160
1200x600	50	160
1200x1200	50	160

Live load/load bearing capacity

INSTALLATION DIAGRAM (M210) FOR ECOPHON EDGE 500 WITH FOCUS DS

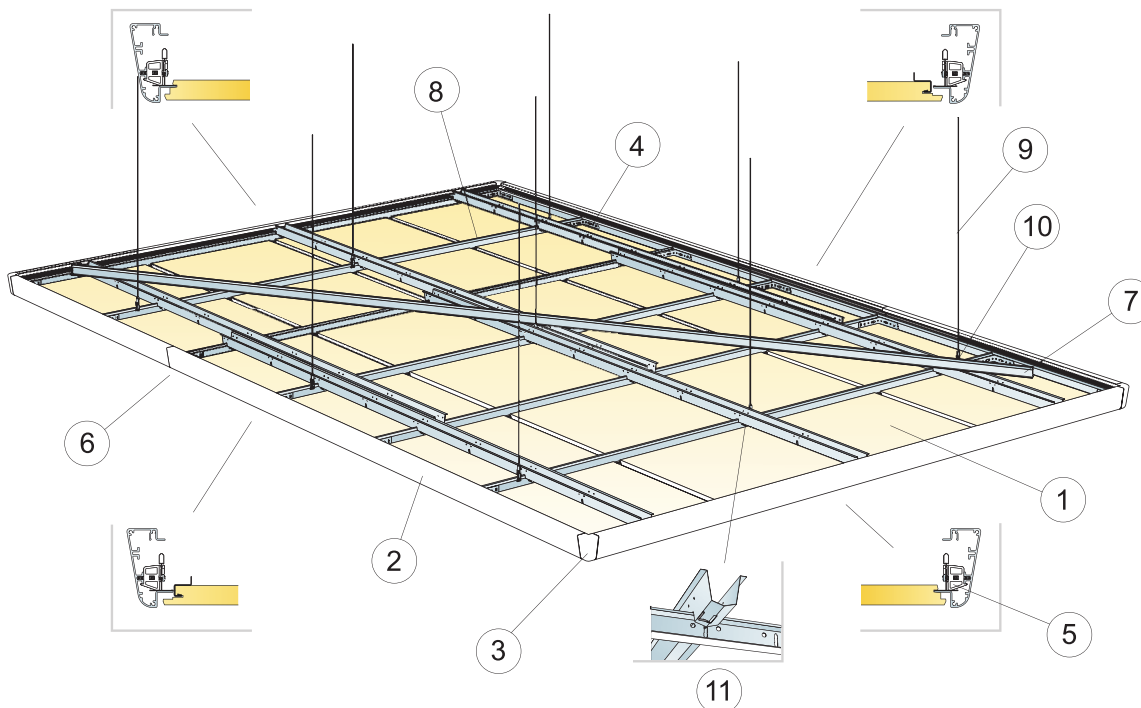

QUANTITY SPECIFICATION (EXCL. WASTAGE)

	Size, mm	
	600x600	1200x600
1 Focus Ds	2,8/m ²	1,4/m ²
2 Connect Edge 500 Profile	as required	as required
3 Connect Edge 500 Corner	as required	as required
4 Connect L-coupling	as required	as required
5 Connect Edge profile clip, (18 pcs/kit included in Connect Edge kit Ds/Dg)	as required	as required
6 Joint with Guide pins and Joint fixing bracket, (see Edge kit for further details)	as required	as required
7 Connect Main runner for adjustment and stabilisation of grid	as required	as required
8 Focus Ds tile and Connect grid system (see Focus Ds system page for further details)	as required	as required
9 Connect Adjustable wire hanger, installed at 1200 mm centres	as required	as required
10 Connect Hanger clip	as required	as required
11 Connect Space bar, installed at 1500 mm centres (max. distance from wall 300 mm)	-	-
12 Connect Space Bar Winch, installed one per joint Connect Main Runner/Connect Space Bar	1,4/m ²	1,4/m ²
Δ Min. overall depth of system: 135 mm	-	-
δ Min. demounting depth: 30 mm (50 mm with 1200x1200)	-	-
Connect Edge kit Ds/Dg consists of the following components:	-	-
18 pcs Connect Edge profile clip with screw RTK 3,5x25, 4 pcs Joint fixing bracket, 1 pc socket screw wrench 2 mm, 1 pc socket screw wrench T10, 12 pcs guide pins, 24 pcs screws RTK ST 3,5x9,5 (for fixing to extrusion), 2 pcs installation guides	-	-
Not included in kit: Connect L-coupling	-	-
Not included in kit: Connect Installation screw BR for L-coupling	-	-

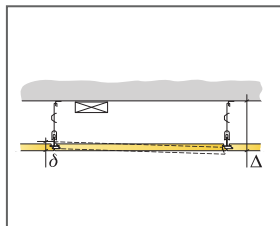

See Quantity specification

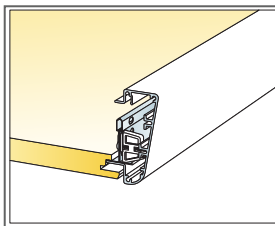

Joint with tile side Ds1

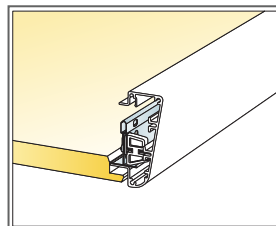

Joint with tile side Ds2 and extra profile

Size, mm	Max live load (N)	Min load bearing capacity (N)
600x600	50	160
1200x600	50	160

Live load/load bearing capacity

INSTALLATION DIAGRAM (M211) FOR ECOPHON EDGE 500 WITH FOCUS DG

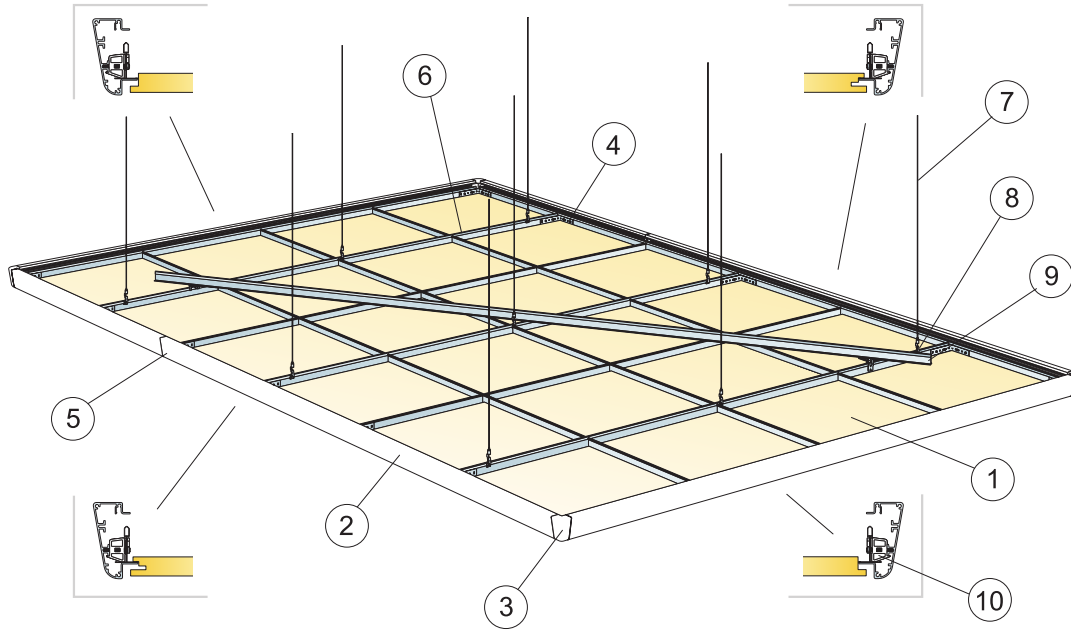

© Ecophon Group

QUANTITY SPECIFICATION (EXCL. WASTAGE)

	Size, mm		
	600x600	1200x600	1200x1200
1 Focus Dg	2,8/m ²	1,4/m ²	0,7/m ²
2 Connect Edge 500 Profile	as required	as required	as required
3 Connect Edge 500 Corner	as required	as required	as required
4 Connect L-coupling	as required	as required	as required
5 Joint with Guide pins and Joint fixing bracket, (see Edge kit for further details)	as required	as required	as required
6 Focus Dg tile and Connect grid system (see Focus Dg system page for further details)	as required	as required	as required
7 Connect Adjustable wire hanger, installed at 1200 mm centres	as required	as required	as required
8 Connect Hanger clip	as required	as required	as required
9 Connect Main runner for adjustment and stabilisation of grid	as required	as required	as required
10 Connect Edge profile clip, (18 pcs/kit included in Connect Edge kit Ds/Dg)	as required	as required	as required
Δ Min. overall depth of system: 135 mm	-	-	-
δ Min. demounting depth: 30 mm (50 mm with 1200x1200)	-	-	-
Connect Edge kit Ds/Dg consists of the following components:	-	-	-
18 pcs Connect Edge profile clip with screw RTK 3,5x25, 4 pcs Joint fixing bracket, 1 pc socket screw wrench 2 mm, 1 pc socket screw wrench T10, 12 pcs guide pins, 24 pcs screws RTK ST 3,5x9,5 (for fixing to extrusion), 2 pcs installation guides	-	-	-
Not included in kit: Connect L-coupling	-	-	-
Not included in kit: Connect Installation screw BR for L-coupling	-	-	-

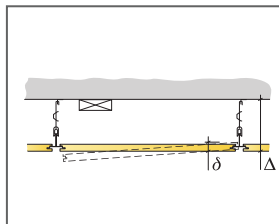

See Quantity specification

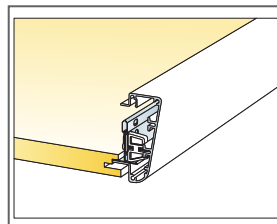

Joint between tile and Edge profile

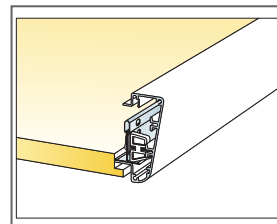

Connection between T-profile and Edge extrusion

Size, mm	Max live load (N)	Min load bearing capacity (N)
600x600	50	160
1200x600	50	160
1200x1200	50	160

Live load/load bearing capacity

Ecophon Focus™ Wing

Ecophon Focus™ Wing installs as the perimeter of a floating ceiling when used together with Ecophon Focus™ Ds or E. It is a system of wing shaped absorbers for free hanging suspended ceilings when a wall to wall ceiling is not preferred.



Seaham Contact Centre, Seaham, United Kingdom

SYSTEM RANGE

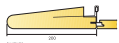

Size, mm	600x200	1200x200
T24	•	•
Thickness (THK)	50	50
Inst. Diagr.	M209	M143, M209

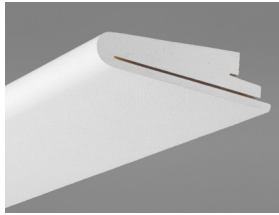

Focus Wing element



Section of Focus Wing system with Connect T24

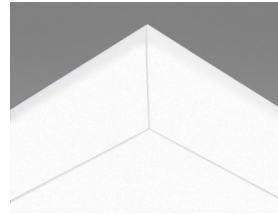

Section of Focus Wing system with Connect T24



Section of Focus Wing system with Connect T24



Acoustic

Ecophon Focus Wing is a perimeter component. As such it is absorbent, however, for acoustic data on the system - please see corresponding ceiling system (Focus Ds or Focus/Master E).



Indoor Air Quality

Certificate / Label

Eurofins Indoor Air Comfort®

IAC Gold

French VOC

A+



Circularity

Minimum post-consumer recycled content

61%

Recyclability

Fully recyclable



Fire safety

Country

Standard

Class

Europe

EN 13501-1

A2-s1,d0

The glass wool core of the tiles is tested and classified as non-combustible according to EN ISO 1182.



Humidity Resistance

Class C, relative humidity 95% and 30°C, according to EN 13964:2014



Visual appearance

White Frost, nearest NCS colour sample S 0500-N, 85% light reflectance. Gloss < 1.



Cleanability

Daily dusting and vacuum cleaning. Weekly wet wiping.



Accessibility

The tiles are not demountable.



Installation

Installed according to installation diagrams, installation guides and drawing aid. For information regarding minimum overall depth of system see quantity specification.



System weight

The systems consist of Ecophon Focus™ Wing elements and Connect™ grid systems, with an approximate weight of 1 kg/m.



Mechanical properties

No additional live load is allowed.



CE

Ecophon ceiling systems are CE marked according to the European harmonized standard EN13964:2014. CE marked construction products are covered by a Declaration of Performance (DOP) which enables customers and users to easily compare performance of products available on the European market.

INSTALLATION DIAGRAM (M143) FOR ECOPHON FOCUS WING E

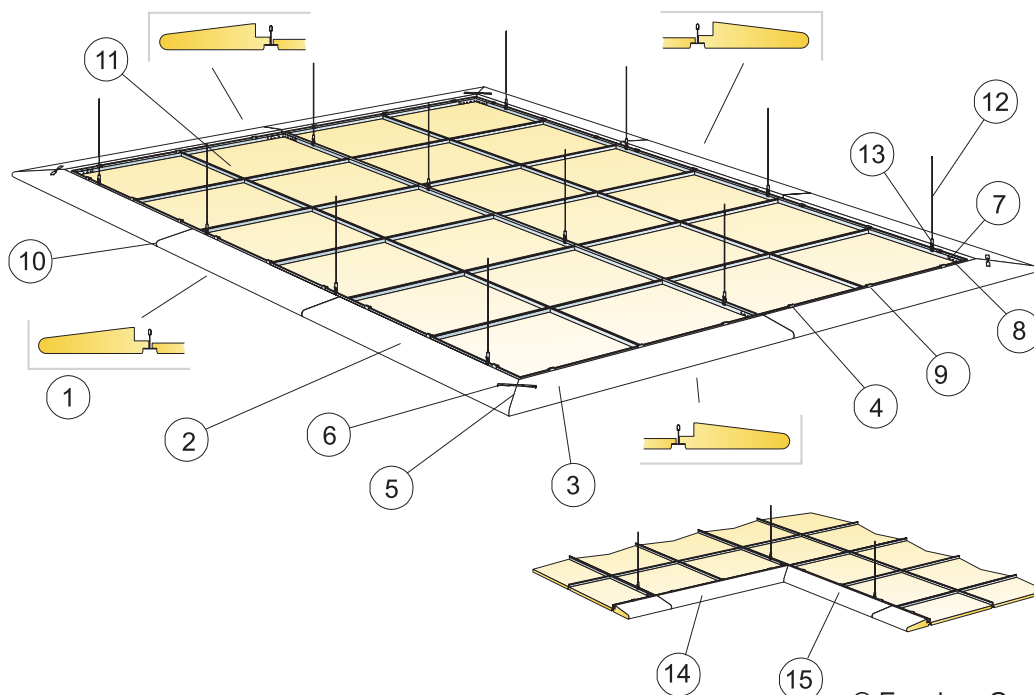

© Ecophon Group

QUANTITY SPECIFICATION (EXCL. WASTAGE)

		Size, mm
		1200x200
1	Focus Wing E (Straight Kit E, see installation guide)	as required
2	Focus Wing E/external corner right (incl. in external corner kit, see installation guide)	as required
3	Focus Wing E/external corner left (incl. in external corner kit, see installation guide)	as required
4	Connect Wing Cantilever (incl. In kits)	as required
5	Connect Spline (incl. in kit)	as required
6	Connect Hook (incl. in kit)	as required
7	Connect L-coupling	as required
8	Connect Installation screw BR	as required
9	Connect Installation Screw MVL (included in kits)	as required
10	Connect Wing Distance	as required
11	Ecophon Focus/Master E system with a frame of Connect Main runner HD	as required
12	Connect Adjustable wire hanger, installed at 1200 mm centres	as required
13	Connect Hanger clip	as required
14	Focus Wing E/internal corner right (incl. in internal corner kit)	as required
15	Focus Wing E/internal corner left (incl. in internal corner kit)	as required
Δ Min. overall depth of system: 130 mm		-
δ Min. demounting depth: See Focus/Master E		-

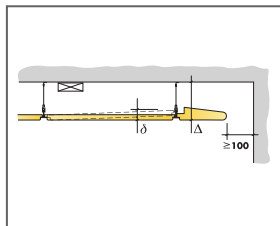

See Quantity specification

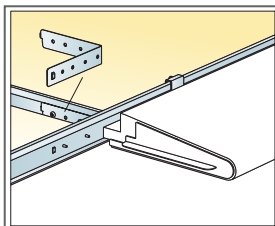

Straight elements are fitted with a special accessory

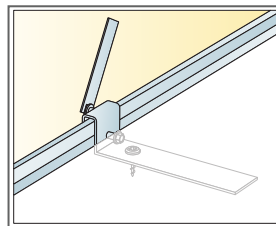

Adjustment of the element

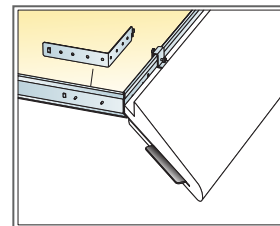

Corner elements are fitted with a spline

INSTALLATION DIAGRAM (M209) FOR ECOPHON FOCUS WING DS

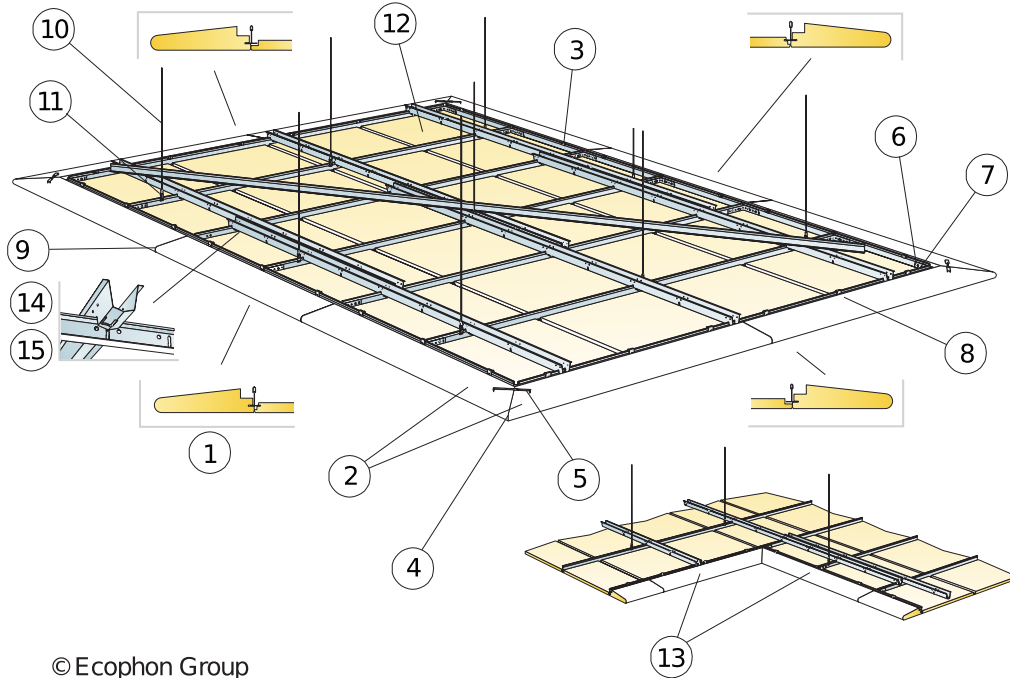

© Ecophon Group

QUANTITY SPECIFICATION (EXCL. WASTAGE)

	Size, mm	
	600x200	1200x200
1 Focus Wing Ds (Straight Kit Ds, see installation guide)	-	as required
2 Focus Wing Ds/external corner (incl. in external corner kit, see installation guide)	-	as required
3 Connect Wing Cantilever (incl. In kits)	-	as required
4 Connect Spline (incl. in kits)	-	as required
5 Connect Hook (incl. in kit)	-	as required
6 Connect L-coupling	-	as required
7 Connect Installation screw BR	-	as required
8 Connect Installation Screw MVL (included in kits)	-	as required
9 Connect Wing Distance	-	as required
10 Connect Adjustable wire hanger, installed at 1200 mm centres	-	as required
11 Connect Hanger clip	-	as required
12 Ecophon Focus Ds system with a frame of Connect Main runner HD	-	as required
13 Focus Wing Ds/internal corner (see internal corner for details)	-	as required
14 Connect Space bar, installed at 1500 mm centres (max. distance from wall 300 mm)	-	as required
15 Connect Space bar winch, installed one per joint Main runner/Space bar	-	-
Δ Min. overall depth of system: 135 mm	-	-
δ Min. demounting depth: 30 mm (50 mm with 1200x1200)	-	-

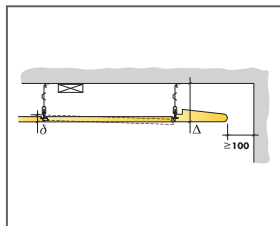

See Quantity specification

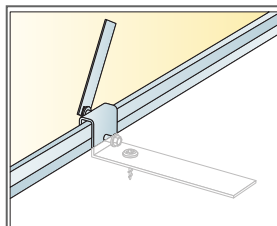

Adjustment of the element

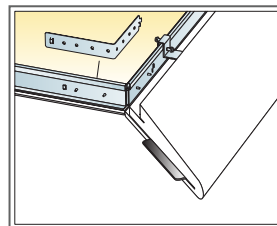

Corner elements are fitted with a spline

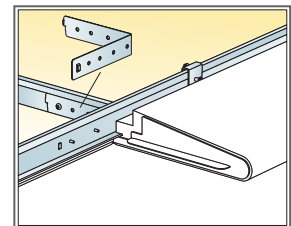

Straight elements are fitted with a special accessory

Ecophon Focus™ Levels

Ecophon Focus™ Levels is a creative system with different thicknesses, sizes and colours. The system is glued edge-to-edge directly to an existing soffit, ceiling or wall. Creates a unique design in levels and patterns.



SYSTEM RANGE



Size, mm	600x600	600x600	600x600	1200x300	1200x300	1200x300	1200x600	1200x600	1200x600
Direct	•	•	•	•	•	•	•	•	•
Thickness (THK)	20	30	40	20	30	40	20	30	40
Inst. Diag.	M488, M489	M488, M489	M488, M489	M488, M489	M488, M489	M488, M489	M488, M489	M488, M489	M488, M489

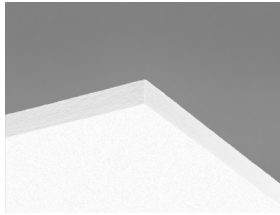

Focus Levels tile

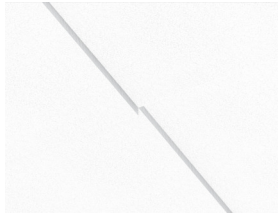

Focus Levels system

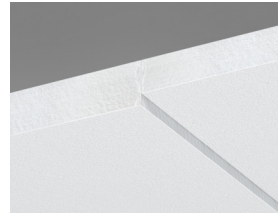

Section of Focus Levels system



Acoustic

Sound Absorption:

Test results according to EN ISO 354. Classification according to EN ISO 11654, and the single value ratings for Noise Reduction Coefficient, NRC and Sound Absorption Average, SAA according to ASTM C 423.

α_p , Practical sound absorption coefficient

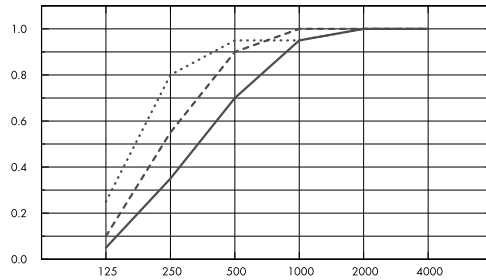

- Focus Levels 40 mm, 43 mm o.d.s.
- Focus Levels 30 mm, 33 mm o.d.s.
- Focus Levels 20 mm, 23 mm o.d.s.

Frequency Hz

α_p , Practical sound absorption coefficient

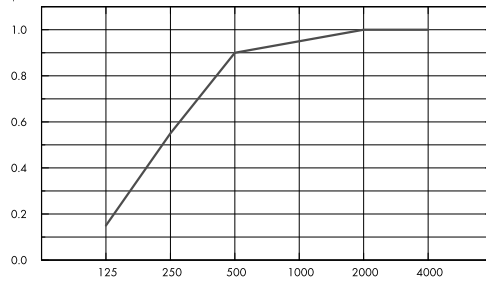

- Focus Levels 20/30/40 mm (M488, M489), 23-43 mm o.d.s.

Frequency Hz

THK mm	o.d.s. mm	α_p , Practical sound absorption coefficient						α_w	Sound absorption class
		125 Hz	250 Hz	500 Hz	1000 Hz	2000 Hz	4000 Hz		
40	43	0.25	0.80	0.95	0.95	1.00	1.00	1.00	A
30	33	0.10	0.55	0.90	1.00	1.00	1.00	0.85	B
20	23	0.05	0.35	0.70	0.95	1.00	1.00	0.65	C
0	43	0.15	0.55	0.90	0.95	1.00	1.00	0.85	B



Indoor Air Quality

Certificate / Label

Eurofins Indoor Air Comfort®

IAC

French VOC

A

Finnish M1

•





Environmental Footprint

Kg CO ₂ equiv/m ²	
Focus Levels 20mm	5,03 (Focus Levels family EPD in conformity with ISO 14025 / EN 15804)
Focus Levels 30mm	6,23 (Focus Levels EPD in conformity with ISO 14025 / EN 15804)
Focus Levels 40mm	7,44 (Focus Levels family EPD in conformity with ISO 14025 / EN 15804)



Circularity

Minimum post-consumer recycled content (20 mm)	58%
Minimum post-consumer recycled content (30 mm)	62%
Minimum post-consumer recycled content (40 mm)	64%
Recyclability	Fully recyclable



Fire safety

Country	Standard	Class
Europe	EN 13501-1	A2-s1,d0

The glass wool core of the tiles is tested and classified as non-combustible according to EN ISO 1182.



Humidity Resistance

Class C, relative humidity 95% and 30°C, according to EN 13964:2014



Visual appearance

White Frost, nearest NCS colour sample S 0500-N, 85% light reflectance. Gloss < 1.



Cleanability

Daily dusting and vacuum cleaning. Weekly wet wiping.



Accessibility

The tiles are not demountable.



Installation

Installed according to installation diagrams, installation guides and drawing aid. For information regarding minimum overall depth of system see quantity specification. Rendered surfaces must have sufficient strength to be able to carry the load imposed by the tiles. If doubts, test gluing should be carried out. The surface should always be dry and clean. For best result the surface should be even, however an acceptable result could be achieved on slightly uneven surfaces.



Mechanical properties

Additional live load has to be fixed to the soffit.



CE

Ecophon ceiling systems are CE marked according to the European harmonized standard EN 13964:2014. CE marked construction products are covered by a Declaration of Performance (DOP) which enables customers and users to easily compare performance of products available on the European market.

INSTALLATION DIAGRAM (M488) FOR ECOPHON FOCUS LEVELS, USING CONNECT ABSORBER GLUE

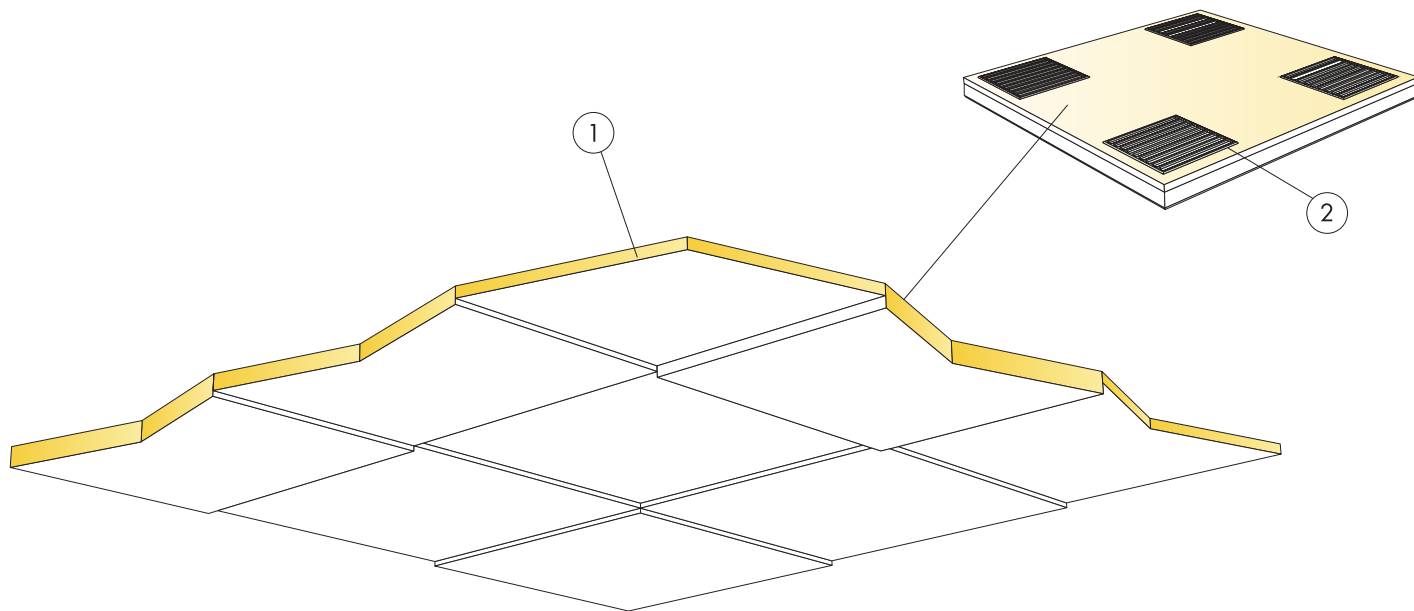

© Ecophon Group

QUANTITY SPECIFICATION (EXCL. WASTAGE)

	Size, mm								
	600x600	600x600	600x600	1200x300	1200x300	1200x300	1200x600	1200x600	1200x600
1 Focus Levels	2,8/m ²	2,8/m ²	2,8/m ²	2,8/m ²	2,8/m ²	2,8/m ²	1,4/m ²	1,4/m ²	1,4/m ²
2 Connect Absorber glue (0,25 l/m ² - 0,4 l/m ² depending on installation conditions)	as required	as required	as required	as required	as required	as required	as required	as required	as required
Use Connect-Notched spatula to apply the glue.	-	-	-	-	-	-	-	-	-
Δ Min. overall depth of system: 23 mm	-	-	-	-	-	-	-	-	-
δ Min. demounting depth: The system is not demountable	-	-	-	-	-	-	-	-	-
Visible edges should be painted	-	-	-	-	-	-	-	-	-
Installation shows 30% of each thickness	-	-	-	-	-	-	-	-	-

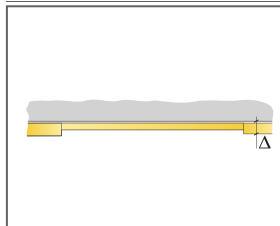

See Quantity specification

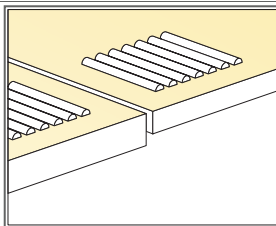

Application of glue

INSTALLATION DIAGRAM (M489) FOR ECOPHON FOCUS LEVELS, USING CONNECT ABSORBER GLUE

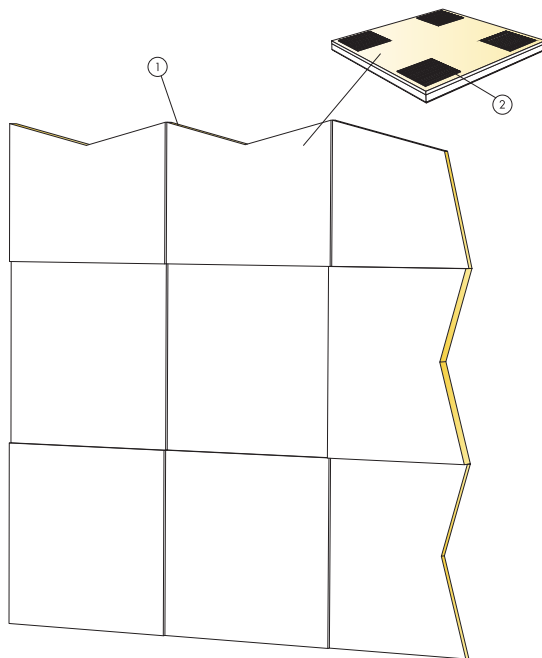

© Ecophon Group

QUANTITY SPECIFICATION (EXCL. WASTAGE)

	Size, mm								
	600x600	600x600	600x600	1200x300	1200x300	1200x300	1200x600	1200x600	1200x600
1 Focus Levels	2,8/m ²	2,8/m ²	2,8/m ²	2,8/m ²	2,8/m ²	2,8/m ²	1,4/m ²	1,4/m ²	1,4/m ²
2 Connect Absorber glue (0,25 l/m ² - 0,4 l/m ² depending on installation conditions)	as required	as required	as required	as required	as required	as required	as required	as required	as required
Use Connect-Notched spatula to apply the glue.	-	-	-	-	-	-	-	-	-
Δ Min. overall depth of system: 23 mm	-	-	-	-	-	-	-	-	-
δ Min. demounting depth: The system is not demountable	-	-	-	-	-	-	-	-	-
Visible edges should be painted	-	-	-	-	-	-	-	-	-
Installation shows 30% of each thickness	-	-	-	-	-	-	-	-	-

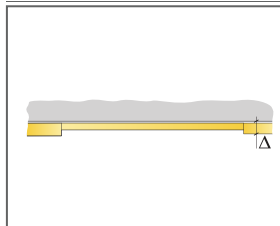

See Quantity specification

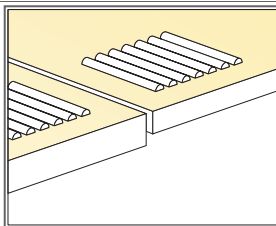

Application of glue