

Ecophon Akusto™ Wall A

Ecophon Akusto™ Wall A has an exposed profile system with a variety of surface options. This wall absorber pairs with a sound absorbing ceiling to achieve excellent acoustic properties in the room.



P20 Office & Business, Poland

SYSTEM RANGE

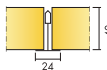

Size, mm	2700x1200
Channel trim	•
Thinline Profile	•
WP Profile	•
Thickness (THK)	40
Inst. Diag.	M353, M504, M509

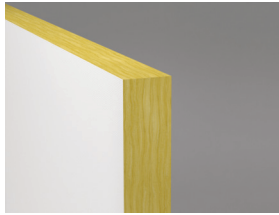

Akusto Wall A



Akusto Wall A system with Connect Channel trim and Connect T24 Main runner

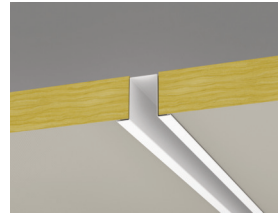

Akusto Wall A system with Connect Channel trim and Connect Recessed profile



Akusto Wall system with Connect Thinline profiles



Acoustic

Sound Absorption:

Test results according to EN ISO 354. Classification according to EN ISO 11654, and the single value ratings for Noise Reduction Coefficient, NRC and Sound Absorption Average, SAA according to ASTM C 423.

α_p , Practical sound absorption coefficient

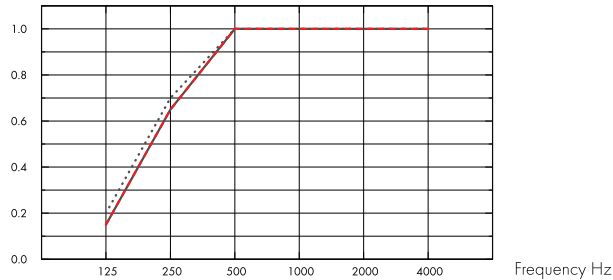

... Akusto Wall A Akutex FT 40 mm, 43 mm o.d.s.

— Akusto Wall A Texona 40 mm, 43 mm o.d.s.

--- Akusto Wall A Super G 40 mm, 43 mm o.d.s.

o.d.s = overall depth of system

	THK mm	o.d.s. mm	α_p , Practical sound absorption coefficient						α_w	Sound absorption class
			125 Hz	250 Hz	500 Hz	1000 Hz	2000 Hz	4000 Hz		
Akutex FT	40	43	0.20	0.70	1.00	1.00	1.00	1.00	1.00	A
Texona	40	43	0.15	0.65	1.00	1.00	1.00	1.00	1.00	A
Super G	40	43	0.15	0.65	1.00	1.00	1.00	1.00	0.95	A

THK mm	AC(1.5)
40	Articulation Class, ASTM E1111, ASTM E1110 230



Indoor Air Quality

Certificate / Label	Standard
Eurofins Indoor Air Comfort®	IAC
French VOC	A
Finnish M1	•



Environmental Footprint

Kg CO₂ equiv/m²: 6,2 From EPD in conformity with ISO 14025 / EN 15804



Circularity

Minimum post-consumer recycled content	53%
Recyclability	Fully recyclable



Fire safety

Country	Standard	Class
Europe	EN 13501-1	A2-s1,d0

The glass wool core of the tiles is tested and classified as non-combustible according to EN ISO 1182.



Humidity Resistance

Class C, relative humidity 95% and 30°C, according to EN 13964:2014



Visual appearance

Akusto in white has high light reflectance. Light reflectance and nearest NCS colour sample for all the different colours: See Ecophon Colours and surfaces.



Cleanability

Daily dusting, vacuum cleaning and weekly wet wiping (Super G and Akutex FT surfaces). Weekly dusting and vacuum cleaning (Texona surface).



Use of disinfectants

Texona Ginger, Sea salt, Thyme, Oyster and Garlic withstand the frequent use of ethanol (70%)-based disinfectants. Dampen a soft polyester microfiber cloth with the solution and wipe the surface in gentle circular movements.



Accessibility

The tiles are not demountable except in selected installation diagrams. See quantity specification for more information.



Installation

Installed according to installation diagrams, installation guides and drawing aid. For information regarding minimum overall depth of system see quantity specification. The systems should not be placed behind goals or similar areas where they frequently will be hit by hard ball shots. In such cases a protective net in front of the system is recommended.



System weight

The weight of the system (including profile system) should be approximately 4 kg/m².



Mechanical properties

No additional live load is allowed.



Impact Resistance

Surface	M-sketch	Class
Super G	M353	Fulfills

Tested and classified to fulfil the requirements of DIN 18032-3, equivalent to 1A according to EN13964. Texona surface has moderate impact resistance. Please note: Where the panels are subjected to frequent blows and impacts e.g. behind goal mouths, protection in form of e.g. restraining nets or wooden slats is required.



CE

Ecophon ceiling systems are CE marked according to the European harmonized standard EN13964:2014. CE marked construction products are covered by a Declaration of Performance (DOP) which enables customers and users to easily compare performance of products available on the European market.

INSTALLATION DIAGRAM (M353) FOR ECOPHON AKUSTO WALL A

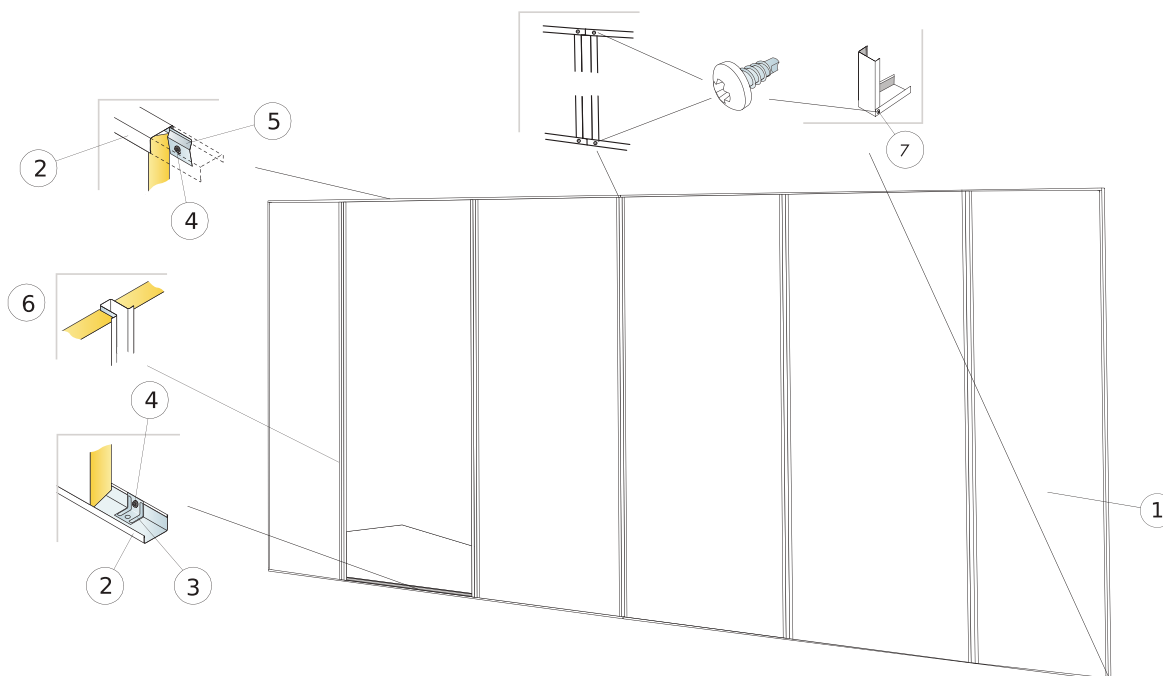

© Ecophon Group

QUANTITY SPECIFICATION (EXCL. WASTAGE)

	Size, mm
	2700x1200
1 Ecophon Akusto Wall A/Super G	0,31/m ²
2 Connect Channel trim, fixed at 300 mm centres. Connect Direct fixing plate is placed inside at each fixing point if the panel is not supported by the floor.	as required
3 Connect Direct fixing plate	as required
4 Connect Installation screw MVL (for use in plasterboard or timber)	as required
5 Connect Fixing bracket, fixed at 400 mm centres.	as required
6 Connect Recessed profile plus	as required
7 Connect Installation screw BR	as required
Δ Min. overall depth of system: 44 mm	-

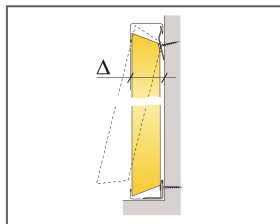

See Quantity specification

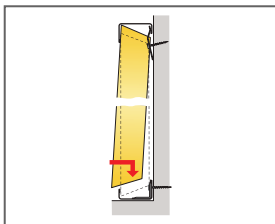

Detail of installation

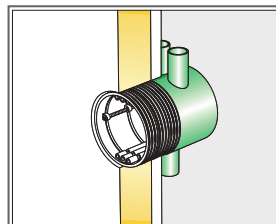

Accessories for adjusting electrical installations are available in electricity retail stores

INSTALLATION DIAGRAM (M504) FOR ECOPHON AKUSTO WALL A

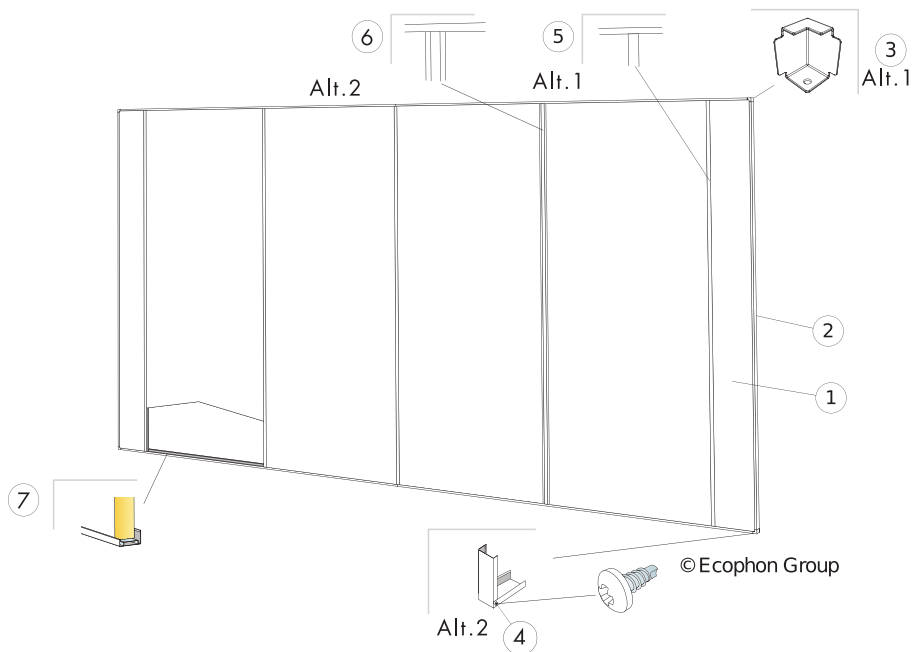

QUANTITY SPECIFICATION (EXCL. WASTAGE)

	Size, mm
	2700x1200
1 Ecophon Akusto Wall A	0,31/m ²
2 Connect Channel trim, fixed at 300 mm centres. Connect Direct fixing plate is placed inside at each fixing point if the panel is not supported by the floor.	as required
3 Alt. 1 Connect Channel trim corner	as required
4 Alt. 2 Connect Installation screw BR	as required
5 Alt. 1 Connect T24 Main runner, (Installation: kept in position with the Channel trims)	as required
6 Alt.1 Connect Recessed profile, (Installation: kept in position with the Channel trims)	as required
7 Connect WP Space bar, L=2400 mm	as required
Δ Min. overall depth of system: 44 mm	-
Connect Installation screw MVL (for use in plasterboard or timber)	as required

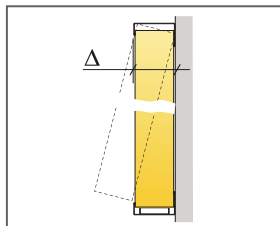

See Quantity specification

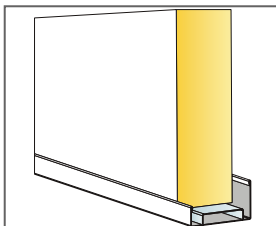

Installation with Channel trim and WP Space bar

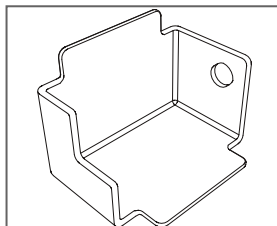

Connect Channel trim corner for 44mm profile

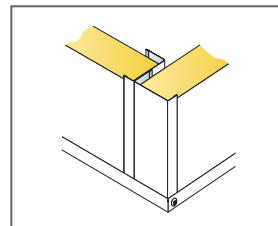

Corner installation with Channel trim and BR screw

INSTALLATION DIAGRAM (M509) FOR ECOPHON AKUSTO WALL A WITH CONNECT THINLINE PROFILES.

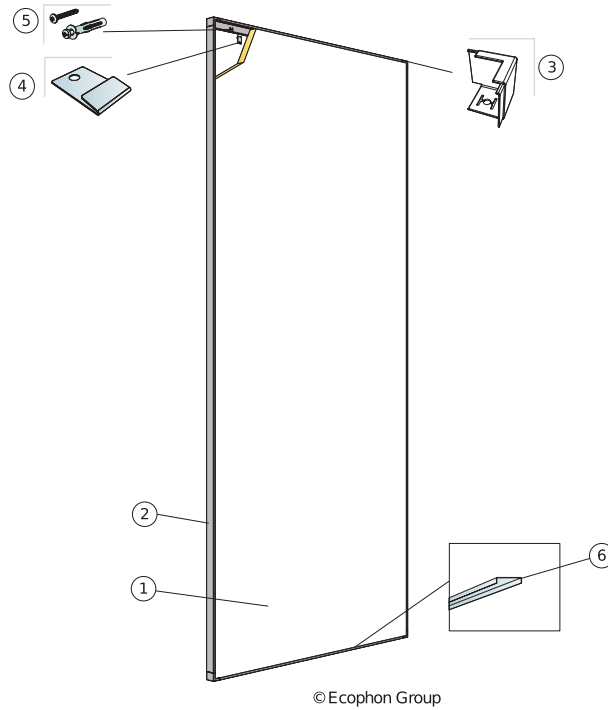

QUANTITY SPECIFICATION (EXCL. WASTAGE)

		Size, mm
		2700x1200
1	Ecophon Akusto Wall A	0,31/m ²
2	Connect Thinline Profile, L=2644 mm	as required
3	Connect Thinline Corner	as required
4	Connect Thinline Locking Clip	as required
5	Installation screw, installed at 400 mm centres (select fastener according to wall material)	as required
6	Connect Thinline Space Bar	as required
Δ Overall depth of system: 45 mm		-

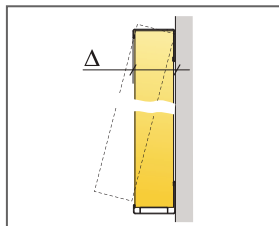

See Quantity specification

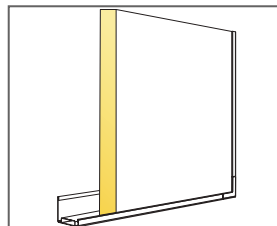

Detail of panel with Thinline system

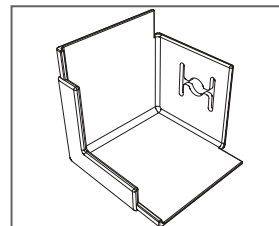

Detail of Thinline corner

Ecophon Akusto™ Wall C

Ecophon Akusto™ Wall C has a concealed grid and bevelled edge to create a narrow groove between each panel. Available in a variety of surface options. Excellent room acoustic properties are achieved when this wall absorber is paired with a sound absorbing ceiling.



Family image, Sweden

SYSTEM RANGE

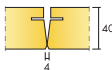

Size, mm	2700x600
Thinline Profile	•
WP Profile	•
Thickness (THK)	40
Inst. Diagr.	M497, M354, M355, M508

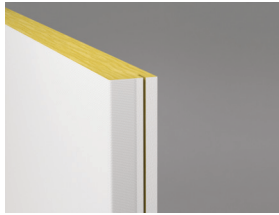

Akusto Wall C



Section of Akusto Wall C System



Akusto Wall C system with Connect WP profile and external corner



Wall Panel C system with Connect WP profile and external corner



Acoustic

Sound Absorption:

Test results according to EN ISO 354. Classification according to EN ISO 11654, and the single value ratings for Noise Reduction Coefficient, NRC and Sound Absorption Average, SAA according to ASTM C 423.

α_p , Practical sound absorption coefficient

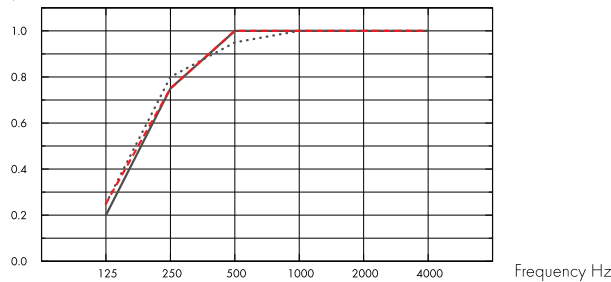

..... Akusto Wall C Akutex FT 40 mm, 43 mm o.d.s.

— Akusto Wall C Texona 40 mm, 43 mm o.d.s.

--- Akusto Wall C Super G 40 mm, 43 mm o.d.s.

o.d.s = overall depth of system

	THK mm	o.d.s. mm	α_p , Practical sound absorption coefficient						α_w	Sound absorption class
			125 Hz	250 Hz	500 Hz	1000 Hz	2000 Hz	4000 Hz		
Akutex FT	40	43	0.25	0.80	0.95	1.00	1.00	1.00	1.00	A
Texona	40	43	0.20	0.75	1.00	1.00	1.00	1.00	1.00	A
Super G	40	43	0.25	0.75	1.00	1.00	1.00	1.00	1.00	A

THK mm	AC(1.5)
40	Articulation Class, ASTM E1111, ASTM E1110 240



Indoor Air Quality

Certificate / Label	Standard
Eurofins Indoor Air Comfort®	IAC
French VOC	A
Finnish M1	•



Environmental Footprint

	Kg CO ₂ equiv/m ²
Akusto Wall C - Texona	7,7 (Akusto Wall C EPD in conformity with ISO 14025 / EN 15804)
Akusto Wall C - Akutex FT	7,4 (Akusto Wall C EPD in conformity with ISO 14025 / EN 15804)
Akusto Wall C - Super G	9,0 (Akusto Wall C EPD in conformity with ISO 14025 / EN 15804)



Circularity

Minimum post-consumer recycled content	60%
Recyclability	Fully recyclable



Fire safety

Country	Standard	Class
Europe	EN 13501-1	A2-s1,d0

The glass wool core of the tiles is tested and classified as non-combustible according to EN ISO 1182.



Humidity Resistance

Class C, relative humidity 95% and 30°C, according to EN 13964:2014



Visual appearance

Akusto in white has high light reflectance. Light reflectance and nearest NCS colour sample for all the different colours: See Ecophon Colours and surfaces.



Cleanability

Daily dusting, vacuum cleaning and weekly wet wiping (Super G and Akutex FT surfaces). Weekly dusting and vacuum cleaning (Texona surface).



Use of disinfectants

Texona Ginger, Sea salt, Thyme, Oyster and Garlic withstand the frequent use of ethanol (70%)-based disinfectants. Dampen a soft polyester microfiber cloth with the solution and wipe the surface in gentle circular movements.



Accessibility

The tiles are not demountable except in selected installation diagrams. See quantity specification for more information.



Installation

Installed according to installation diagrams, installation guides and drawing aid. For information regarding minimum overall depth of system see quantity specification. The systems should not be placed behind goals or similar areas where they frequently will be hit by hard ball shots. In such cases a protective net in front of the system is recommended.



System weight

The weight of the system (including profile system) should be approximately 5 kg/m².



Mechanical properties

No additional live load is allowed.



Impact Resistance

Surface	M-sketch
Super G	M354

Tested and classified to fulfil the requirements of DIN 18032-3, equivalent to 1A according to EN13964.



CE

Ecophon ceiling systems are CE marked according to the European harmonized standard EN 13964:2014. CE marked construction products are covered by a Declaration of Performance (DOP) which enables customers and users to easily compare performance of products available on the European market.

INSTALLATION DIAGRAM (M497) FOR ECOPHON AKUSTO WALL C VERTICAL INSTALLATION WITH CONNECT THINLINE PROFILES.

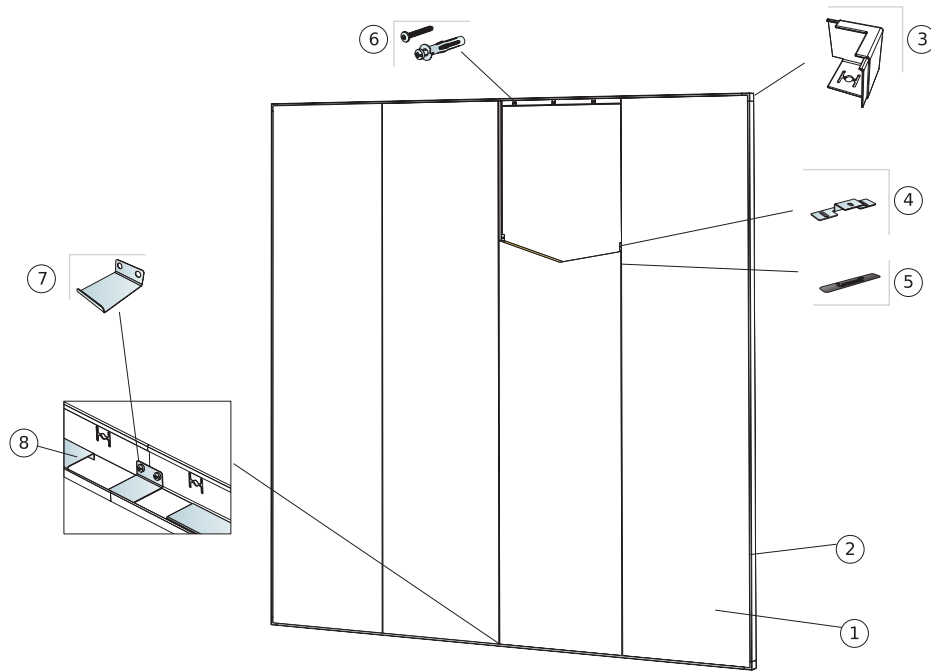

© Ecophon Group

QUANTITY SPECIFICATION (EXCL. WASTAGE)

	Size, mm
	2700x600
1 Akusto Wall C	0,62/m ²
2 Connect Thinline Profile, L=2644 mm	as required
3 Connect Thinline Corner	as required
4 Connect Fixing Plate installed 3 per panel length	as required
5 Connect Spline	as required
6 Installation screw, installed at 400 mm centres (select fastener according to wall material)	as required
7 Connect Thinline Splice. used to extend Thinline profiles where needed.	as required
8 Connect Thinline Space Bar	as required
Δ Overall depth of system: 45 mm	-

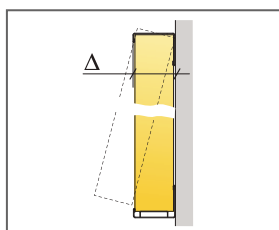

See Quantity specification

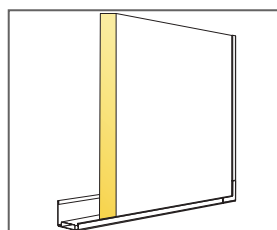

Detail of panel with Thinline system

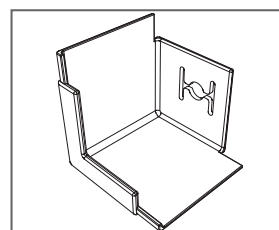

Detail of Thinline corner

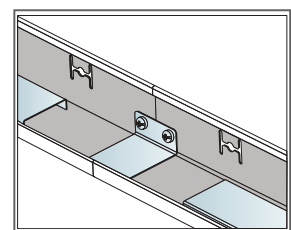

Detail of Thinline splice

INSTALLATION DIAGRAM (M354) FOR ECOPHON AKUSTO WALL C VERTICAL INSTALLATION

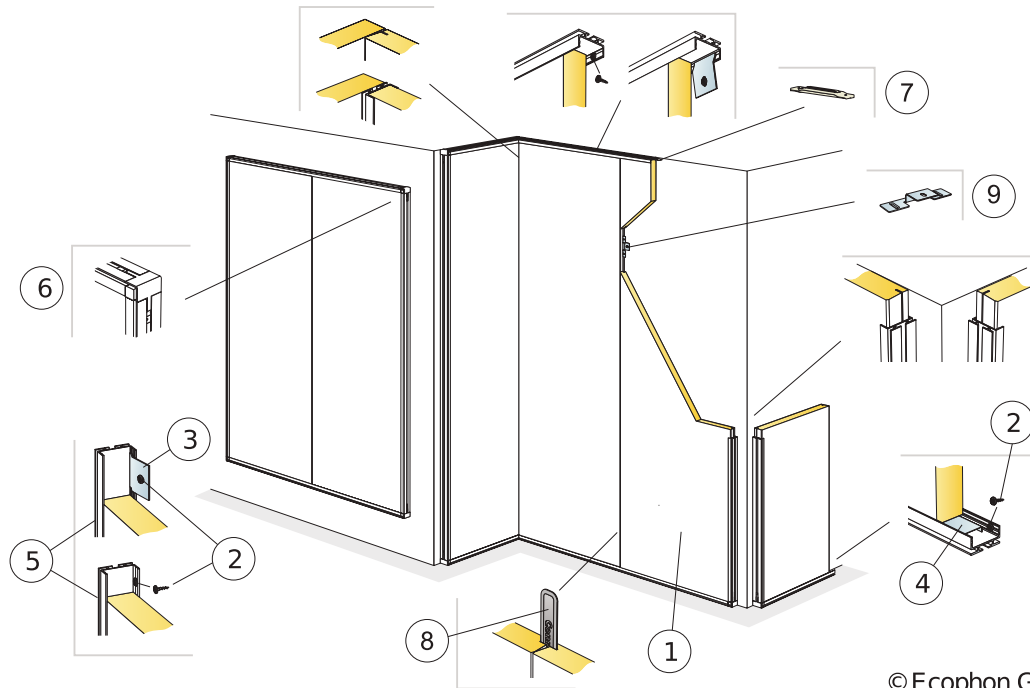

© Ecophon Group

QUANTITY SPECIFICATION (EXCL. WASTAGE)

	Size, mm
	2700x600
1 Akusto Wall C (Akusto Wall C/Super G for Ball Impact Resistance)	0,62/m ²
2 Connect Installation screw MVL (for use in plasterboard or timber)	as required
3 Alt. Connect Fixing bracket, fixed at 400 mm centres.	as required
4 Connect WP Space bar, L=2400 mm	as required
5 Connect WP Profile, L=2687 mm, fixed at 400 mm centres	as required
6 Connect WP External corner mounted in Connect WP Profile	as required
7 Connect WP Profile splice, used to extend WP profiles where needed.	as required
8 Connect Spline	as required
9 Connect Fixing Plate installed 3 per panel length	as required
Δ Min. overall depth of system: 44 mm	

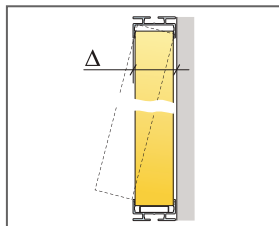

See Quantity specification

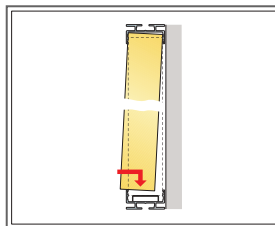

Detail of installation

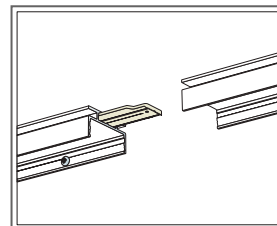

Detail of WP Profile splice

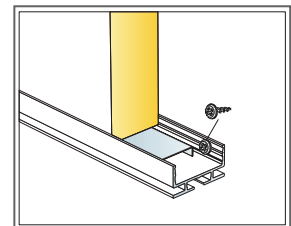

Detail of lower connection

INSTALLATION DIAGRAM (M355) FOR ECOPHON AKUSTO WALL C HORIZONTAL INSTALLATION

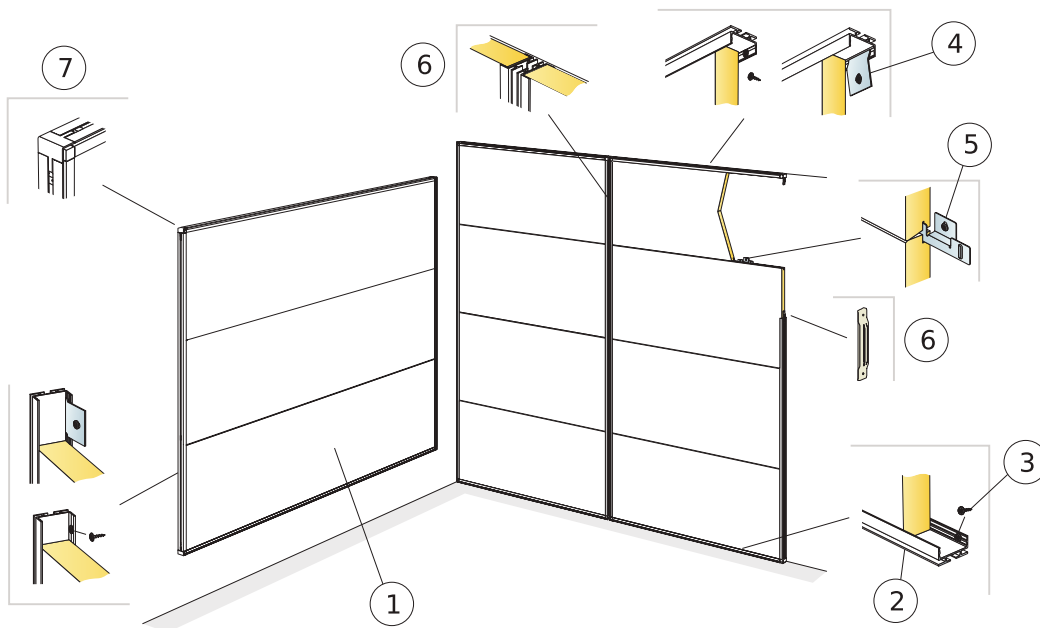

© Ecophon Group

QUANTITY SPECIFICATION (EXCL. WASTAGE)

		Size, mm
		2700x600
1	Akusto Wall C	0,62/m ²
2	Connect WP Profile, L=2687 mm, fixed at 400 mm centres	as required
3	Connect Installation screw MVL (for use in plasterboard or timber)	as required
4	Alt. Connect Fixing bracket, fixed at 400 mm centres.	as required
5	Connect Fixing Plate installed 3 per panel length	as required
6	Connect WP Profile splice, used to extend WP profiles where needed.	as required
7	Connect WP External corner mounted in Connect WP Profile	as required
Δ Min. overall depth of system: 44 mm		-

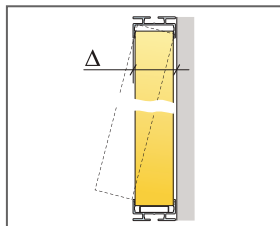

See Quantity specification

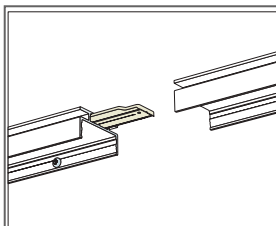

Detail of WP Profile splice

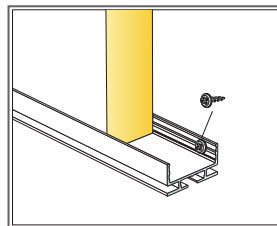

Detail of lower connection

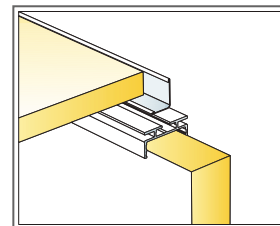

Detail of junction to acoustic ceiling

INSTALLATION DIAGRAM (M508) FOR ECOPHON AKUSTO WALL C HORIZONTAL INSTALLATION

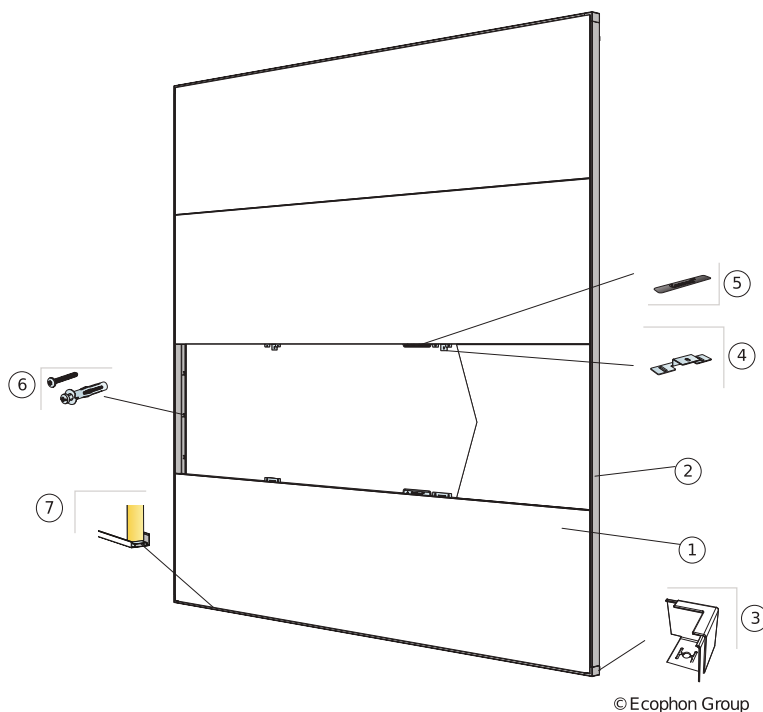

QUANTITY SPECIFICATION (EXCL. WASTAGE)

	Size, mm
	2700x600
1 Akusto Wall C	0,62/m ²
2 Connect Thinline Profile, L=2644 mm	as required
3 Connect Thinline Corner	as required
4 Connect Fixing Plate installed 3 per panel length	as required
5 Connect Spline	as required
6 Installation screw, installed at 400 mm centres (select fastener according to wall material)	as required
7 Connect Thinline Space Bar	as required
Δ Overall depth of system: 45 mm	-

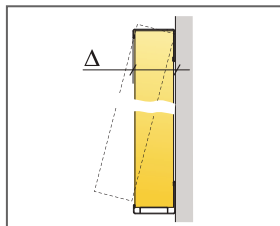

See Quantity specification

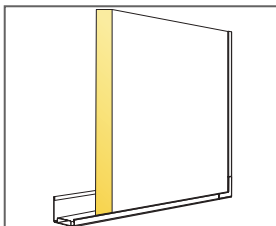

Detail of panel with Thinline system

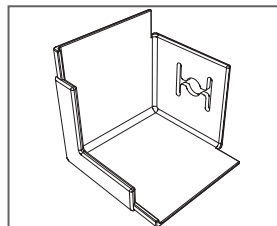

Detail of Thinline corner

Ecophon Akusto™ Screen

Ecophon Akusto™ Screen has an exposed profile system. The size of the product is 1500 x 1200mm, thickness 40 mm. Available in Texona and Caretec surface. Suitable for open space offices. Combined with a sound absorbing ceiling to achieve excellent acoustic properties in the room.



SYSTEM RANGE

	Size, mm	1500x1200
	Freestanding	•
	Thickness (THK)	40
	Inst. Diagr.	M526



Akusto Screen foot



Akusto Floor corner

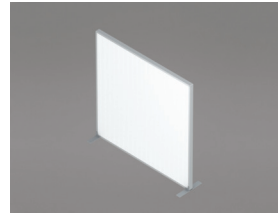

Akusto Screen system



Acoustic

Sound Absorption:

Sound absorption and sound attenuation test results according to ISO 20189.

A_{eq} Equivalent absorption area per unit (m^2 sabin)

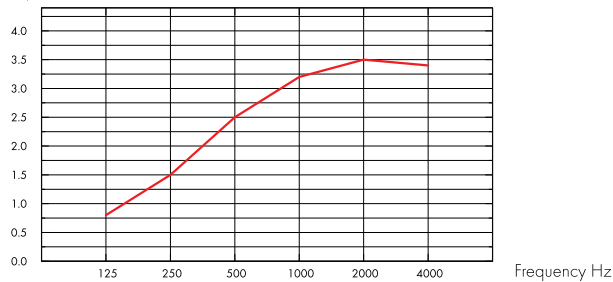

— Akusto Screen, size 1500x1200 mm

Screen sound attenuation ΔL_s (dB)

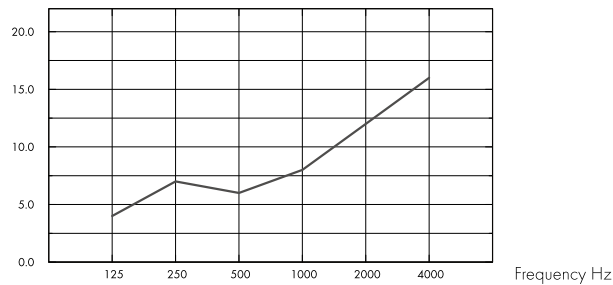

— Akusto Screen, size 1500x1200 mm.

	THK mm	A_{eq} Equivalent absorption area per unit (m^2 sabin)					
		125 Hz	250 Hz	500 Hz	1000 Hz	2000 Hz	4000 Hz
1500x1200	40	0.8	1.5	2.5	3.2	3.5	3.4

	THK mm	Screen sound attenuation ΔL_s (dB)						Weighted screen sound attenuation (dB)
		125 Hz	250 Hz	500 Hz	1000 Hz	2000 Hz	4000 Hz	
1500x1200	40	4.0	7.0	6.0	8.0	12.0	16.0	10.0



Indoor Air Quality

Certificate / Label

French VOC, A



Humidity Resistance

Class A, relative humidity 70% and 25°C, according to EN 13964:2014



Circularity

Fully recyclable.



Visual appearance

Texona in white and Caretec has high light reflectance. For more information regarding visual appearance of the various surfaces: See Ecophon Colours and surfaces.



Cleanability

Weekly dusting and vacuum cleaning. The Caretec surface also withstands weekly wet wiping.



Use of disinfectants

The Caretec surface and Texona Ginger, Sea salt, Thyme, Oyster and Garlic withstand the frequent use of ethanol (70%)-based disinfectants. Additionally, Caretec withstands Klorilli (chloramine 0,1 %). Dampen a soft polyester microfiber cloth with the solution and wipe the surface in gentle circular movements.



Installation

Installed according to the installation guide that is delivered with the product.



Mechanical properties

The product is tested according to EN14073-2 and EN1023.

INSTALLATION DIAGRAM (M515) FOR ECOPHON AKUSTO SCREEN

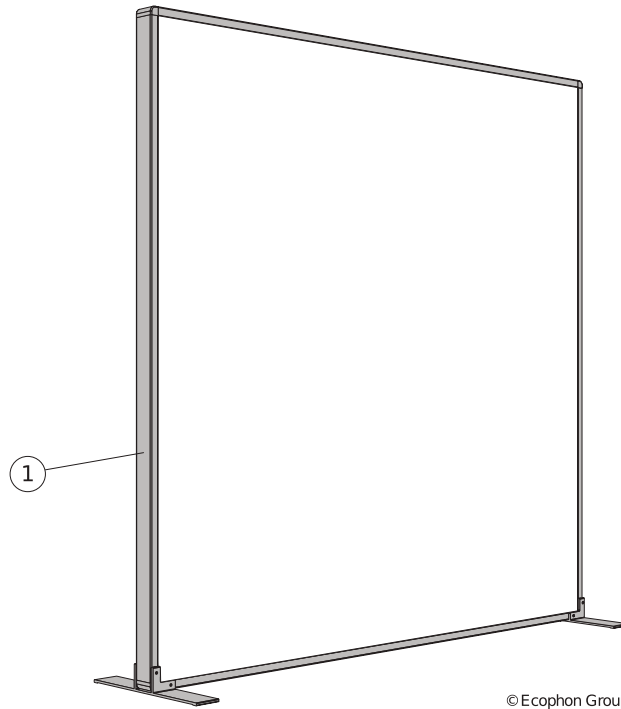

QUANTITY SPECIFICATION (EXCL. WASTAGE)

		Size, mm
		1500x1200
1	Akusto Screen	-

Ecophon Akusto™ One

Ecophon Akusto™ One is a panel for wall applications offered in square, rectangle or circle shapes. It offers a multitude of design possibilities thanks to the many different formats and colours.



Heisingborg, Sweden

SYSTEM RANGE

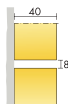

Size, mm	Ø592	592x592	Ø792	Ø1192	1192x292	1192x592
Special Fixing	•	•	•	•	•	•
Thickness (THK)	40	40	40	40	40	40
Inst. Diagr.	M372	M371	M372	M372	M371	M371

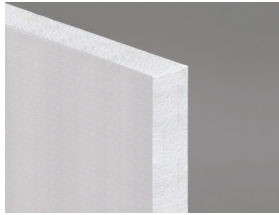

Akusto One panel

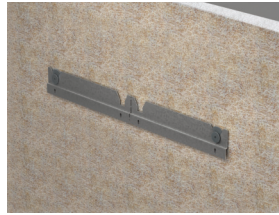

Installation with Connect™ One trim and Connect™ Absorber anchor one



Installation with Connect™ One hook fixing



Acoustic

The values in the diagram refer to a single unit. If the units are arranged in a cluster with distances between units less than 0,5 meters, the Aeq per unit will be slightly reduced.

Sound Absorption:

Test results according to EN ISO 354.

A_{eq} Equivalent absorption area per unit (m² sabin)

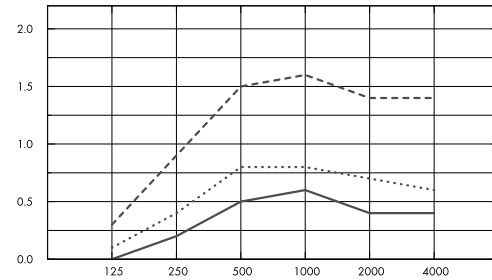

- Akusto One Ø592, 48 mm o.d.s.
 - Akusto One Ø792, 48 mm o.d.s.
 - Akusto One Ø1192, 48 mm o.d.s.
- o.d.s = overall depth of system

Frequency Hz

A_{eq} Equivalent absorption area per unit (m² sabin)

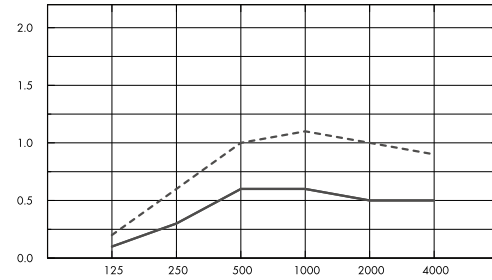

- Akusto One 592x592, 48 mm o.d.s.
 - Akusto One 1192x292, 48 mm o.d.s.
 - Akusto One 1192x592, 48 mm o.d.s.
- o.d.s = overall depth of system

Frequency Hz

	THK mm	o.d.s. mm	A _{eq} Equivalent absorption area per unit (m ² sabin)					
			125 Hz	250 Hz	500 Hz	1000 Hz	2000 Hz	4000 Hz
Ø592	40	48	0.0	0.2	0.5	0.6	0.4	0.4
Ø792	40	48	0.1	0.4	0.8	0.8	0.7	0.6
Ø1192	40	48	0.3	0.9	1.5	1.6	1.4	1.4
592x592	40	48	0.1	0.3	0.6	0.6	0.5	0.5
1192x292	40	48	0.1	0.3	0.6	0.6	0.5	0.5
1192x592	40	48	0.2	0.6	1.0	1.1	1.0	0.9



Indoor Air Quality

Certificate / Label

Eurofins Indoor Air Comfort®

IAC

French VOC

A

Finnish M1

•





Environmental Footprint

Kg CO ₂ equiv/m ²	
Akusto One - Akutex FT	7,35 (Ecophon Akusto family EPD in conformity with ISO 14025 / EN 15804)
Akusto One - Texona	9,42 (Ecophon Akusto family EPD in conformity with ISO 14025 / EN 15804)



Circularity

Minimum post-consumer recycled content	61%
Recyclability	Fully recyclable



Fire safety

Country	Standard	Class
Europe	EN 13501-1	A2-s1,d0

The glass wool core of the tiles is tested and classified as non-combustible according to EN ISO 1182.



Humidity Resistance

Class C, relative humidity 95% and 30°C, according to EN 13964:2014



Visual appearance

Akusto in white has high light reflectance. Light reflectance and nearest NCS colour sample for all the different colours: See Ecophon Colours and surfaces.



Cleanability

Daily dusting, vacuum cleaning and weekly wet wiping (Akutex FT surfaces). Weekly dusting and vacuum cleaning (Texona surface).



Accessibility

The tiles are easily demountable.



Installation

Installed according to installation diagrams, installation guides and drawing aid. For information regarding minimum overall depth of system see quantity specification.



System weight

The weight of the system (depending on size and including profile system) should be approximately 2,0 - 4,5 kg.



Mechanical properties

No additional live load is allowed.



CE

Ecophon ceiling systems are CE marked according to the European harmonized standard EN 13964:2014. CE marked construction products are covered by a Declaration of Performance (DOP) which enables customers and users to easily compare performance of products available on the European market.

INSTALLATION DIAGRAM (M371) FOR ECOPHON AKUSTO ONE

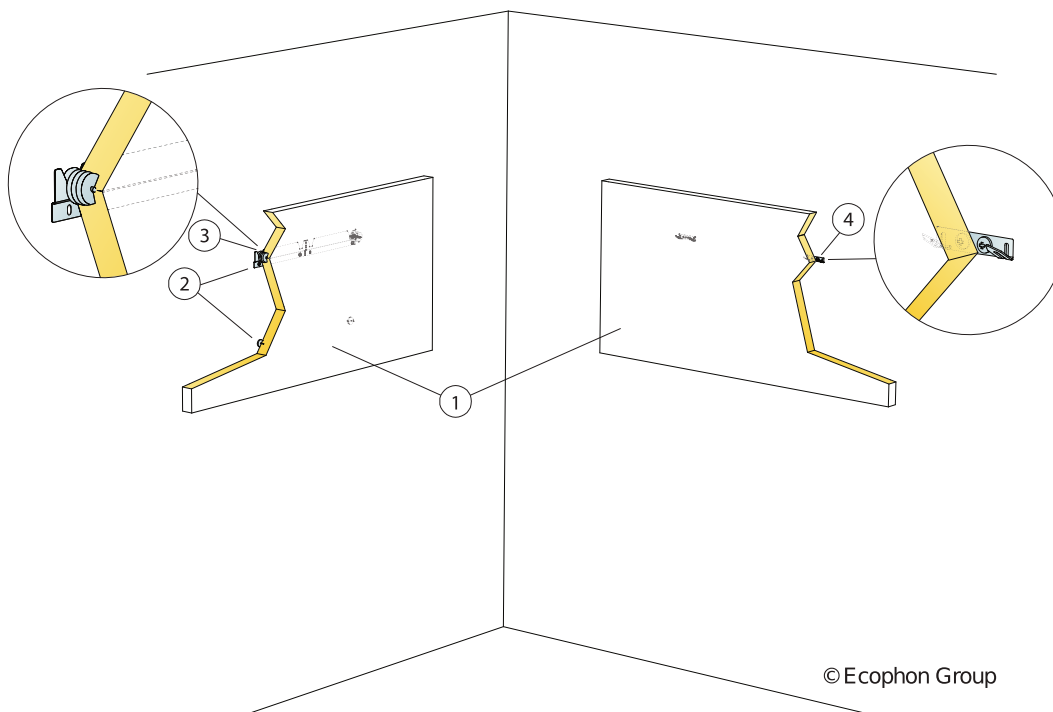

© Ecophon Group

QUANTITY SPECIFICATION (EXCL. WASTAGE)

	Size, mm		
	592x592	1192x292	1192x592
1 Akusto One	2,8/m ²	2,8/m ²	1,4/m ²
2 Alt. 1 Connect One trim (wall distance included)	1/panel	1/panel	1/panel
3 Alt. 1 Connect Absorber anchor one	2/panel	2/panel	2/panel
4 Alt. 2 Connect One hook fixing	2/panel	2/panel	2/panel
Δ Min. overall depth of system: Δ1 48 mm / Δ2 44 mm	-	-	-

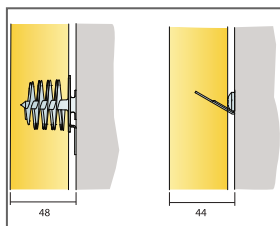

See Quantity specification

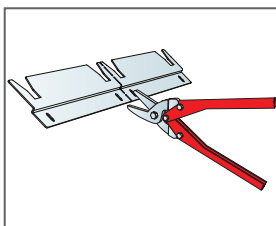

Connect One trim can be divided into two suspension trims

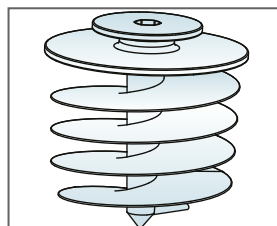

Connect Absorber anchor one used together with Connect One trim

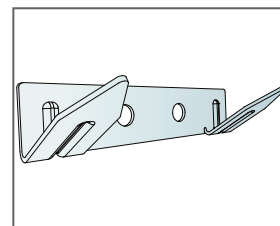

Connect One hook fixing

INSTALLATION DIAGRAM (M372) FOR ECOPHON AKUSTO ONE

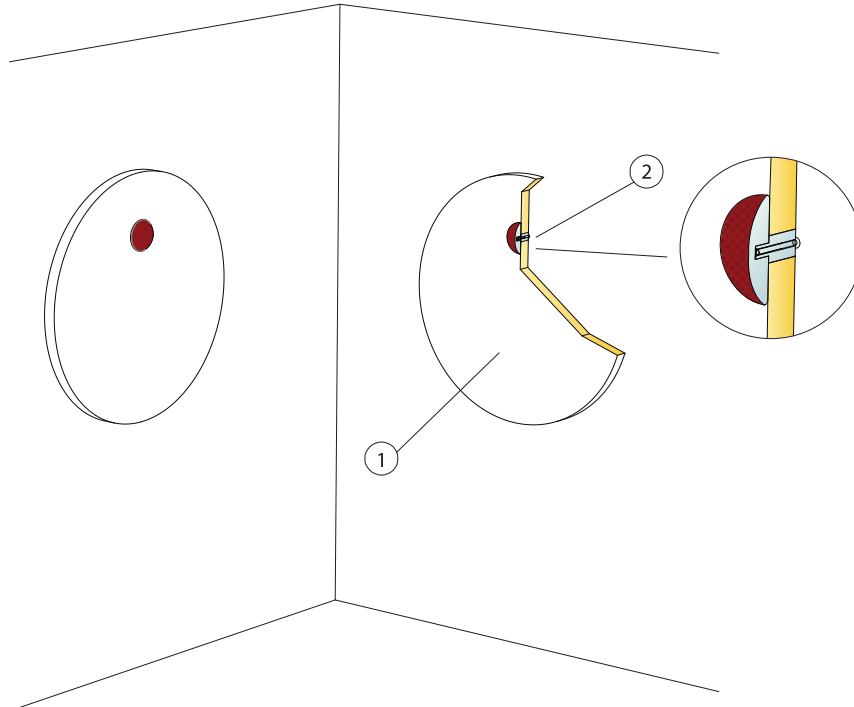

QUANTITY SPECIFICATION (EXCL. WASTAGE)

		Size, mm		
		Ø592	Ø792	Ø1192
1	Akusto One	3,5/m ²	2/m ²	0,9/m ²
2	Connect One fixing	1/panel	1/panel	1/panel
Δ Min. overall depth of system: 40 mm		-	-	-

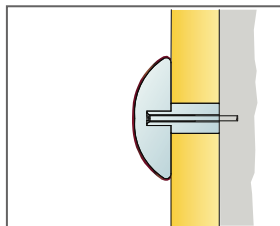

See Quantity specification

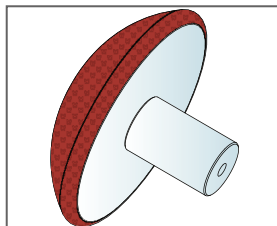

Connect One fixing available in 4 different colours

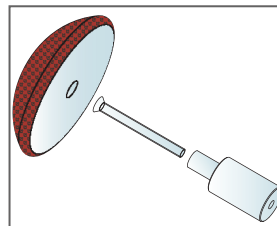

Installation with Connect One fixing



Ecophon Akusto™ Wall C Akutex HS

Ecophon Akusto™ Wall C Akutex HS has a concealed grid and bevelled edge to create a narrow groove between each panel. Suitable for swimming pool areas, it's compatible with high humidity, corrosivity and occasional direct water.



SYSTEM RANGE

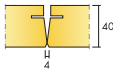

Size, mm	2700x600
Thinline Profile	•
Thickness (THK)	40
Inst. Diagr.	M505C4

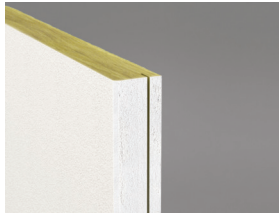

Akusto Wall C Akutex HS



Section of Akusto Wall C Akutex HS System



Akusto Wall Akutex HS system with Connect Thinline Profile and distance



Acoustic

Sound Absorption:

Test results according to EN ISO 354. Classification according to EN ISO 11654.

α_p , Practical sound absorption coefficient

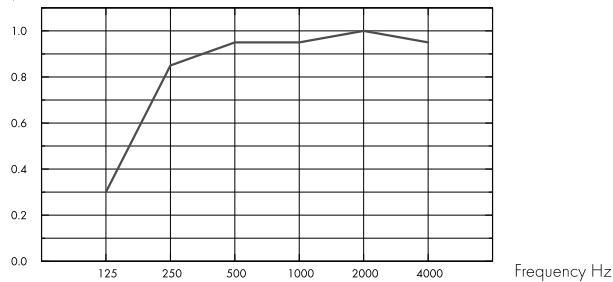

– Akusto Wall C Akutex HS 40 mm, 60 mm o.d.s.

o.d.s = overall depth of system

THK mm	o.d.s. mm	α_p , Practical sound absorption coefficient						α_w	Sound absorption class
		125 Hz	250 Hz	500 Hz	1000 Hz	2000 Hz	4000 Hz		
40	60	0.30	0.85	0.95	0.95	1.00	0.95	1.00	A



Indoor Air Quality

Certificate / Label	
Euofins Indoor Air Comfort®	IAC
French VOC	A
Finnish M1	•



Environmental Footprint

Kg CO ₂ equiv/m ²	
Akusto Wall C - Akutex HS	7,77 (Ecophon Akusto family EPD in conformity with ISO 14025 / EN 15804)



Circularity

Minimum post-consumer recycled content	60%
Recyclability	Fully recyclable



Fire safety

Country	Standard	Class
Europe	EN 13501-1	A2-s1,d0

The glass wool core of the tiles is tested and classified as non-combustible according to EN ISO 1182.



Humidity Resistance

Class C, relative humidity 95% and 30°C, according to EN 13964:2014



Visual appearance

White 500, nearest NCS colour sample S 0500-N, 84% light reflectance.



Cleanability

Daily dusting and vacuum cleaning. Weekly wet wiping.



Accessibility

The tiles are not demountable except in selected installation diagrams. See quantity specification for more information.



Installation

Installed according to installation diagrams, installation guides and drawing aid. For information regarding minimum overall depth of system see quantity specification. The systems should not be placed behind goals or similar areas where they frequently will be hit by hard ball shots. In such cases a protective net in front of the system is recommended.



Mechanical properties

See table about Max live load and Min load bearing capacity and Functional demands, Mechanical properties at www.ecophon.com.



CE

Ecophon ceiling systems are CE marked according to the European harmonized standard EN 13964:2014. CE marked construction products are covered by a Declaration of Performance (DOP) which enables customers and users to easily compare performance of products available on the European market.

INSTALLATION DIAGRAM (M505C4) FOR ECOPHON AKUSTO™ WALL C AKUTEX HS VERTICAL INSTALLATION WITH CONNECT THINLINE PROFILE AND DISTANCE.

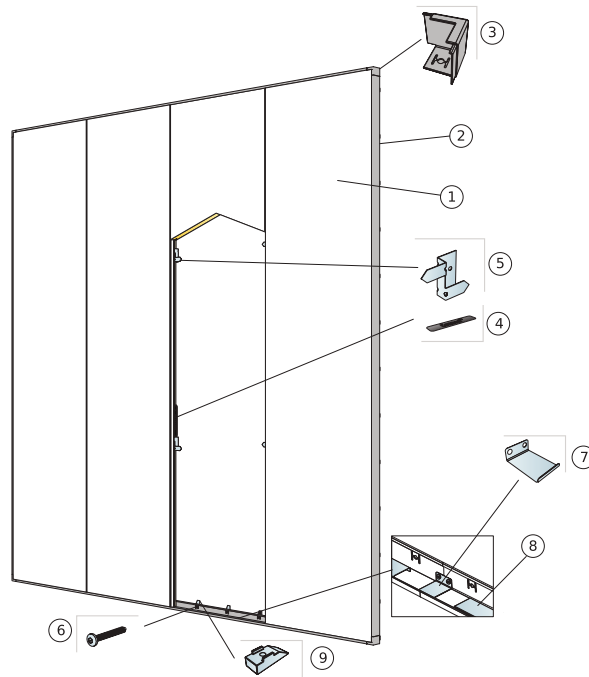

© Ecophon Group

QUANTITY SPECIFICATION [EXCL. WASTAGE]

	Size, mm
	2700x600
1 Akusto Wall C Akutex HS	0,62/m ²
2 Connect Thinline Profile, L=2644 mm	as required
3 Connect Thinline Corner	as required
4 Connect Spline	as required
5 Connect Thinline Fixing C4, for panel support every 1000 mm	as required
6 Installation screw C4, installed at 200 mm centres (select fastener according to wall material)	as required
7 Connect Thinline Splice, used to extend Thinline profiles where needed.	as required
8 Connect Thinline Space Bar	as required
9 Connect Distance C4, installed at 200 mm centres	as required
Δ Overall depth of system: 55 mm	-

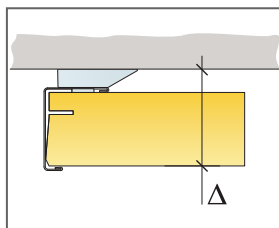

See Quantity Specification

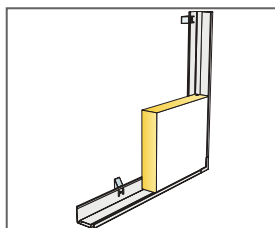

Detail of panel with Thinline system with distance

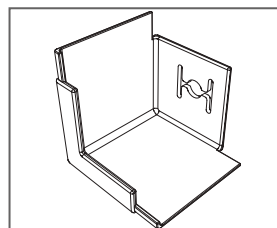

Detail of Thinline corner



Ecophon Akusto™ Wall C Extra Bass

Ecophon Akusto™ Wall C Extra Bass has a concealed grid and bevelled edge to create a narrow groove between each panel. Available in a variety of surface options. The wall absorber has excellent sound absorption qualities from low to high sound frequencies. Best room acoustic properties are achieved when used together with a sound absorbing ceiling.



Family image, Sweden

SYSTEM RANGE

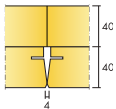

Size, mm	2700x600
Extra Bass	•
Thickness (THK)	40
Inst. Diag.	M535, M547



Akusto Wall C Extra Bass system



Akusto Wall C Extra Bass system from above

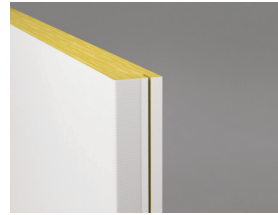

Akusto Wall C



Acoustic

Sound Absorption:

Test results according to EN ISO 354. Classification according to EN ISO 11654, and the single value ratings for Noise Reduction Coefficient, NRC and Sound Absorption Average, SAA according to ASTM C 423.

α_p , Practical sound absorption coefficient

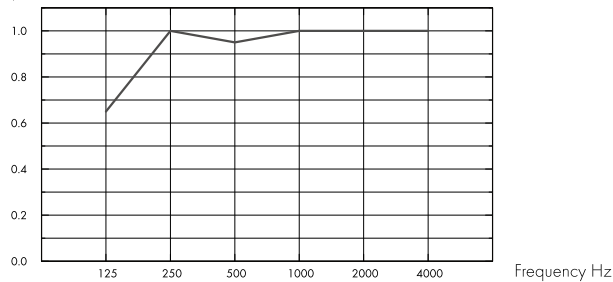

– Akusto Wall C Extra Bass 80 mm, 80 mm o.d.s.
o.d.s = overall depth of system

	THK mm	o.d.s. mm	α_p , Practical sound absorption coefficient						α_w	Sound absorption class
			125 Hz	250 Hz	500 Hz	1000 Hz	2000 Hz	4000 Hz		
Extra Bass	80	80	0.65	1.00	0.95	1.00	1.00	1.00	1.00	A

THK mm	o.d.s. mm	NRC	SAA
80	80	1.00	1.00



Indoor Air Quality

Certificate / Label	
Eurofins Indoor Air Comfort®	IAC
French VOC	A
Finnish M1	•



Environmental Footprint

Kg CO ₂ equiv/m ²	
Akusto Wall C Extra Bass/Texona	10,8 (Akusto Wall C Extra Bass EPD in conformity with ISO 14025 / EN 15804)
Akusto Wall C Extra Bass/Akutex FT	10,4 (Akusto Wall C Extra Bass EPD in conformity with ISO 14025 / EN 15804)



Circularity

Minimum post-consumer recycled content	60%
Recyclability	Fully recyclable



Fire safety

Country	Standard	Class
Europe	EN 13501-1	A2-s1,d0

The glass wool core of the tiles is tested and classified as non-combustible according to EN ISO 1182.



Humidity Resistance

Class C, relative humidity 95% and 30°C, according to EN 13964:2014



Visual appearance

Akusto in white has high light reflectance. Light reflectance and nearest NCS colour sample for all the different colours: See Ecophon Colours and surfaces.



Cleanability

Daily dusting, vacuum cleaning and weekly wet wiping (Akutex FT surfaces). Weekly dusting and vacuum cleaning (Texona surface).



Accessibility

The tiles are not demountable.



Installation

Installed according to installation diagrams, installation guides and drawing aid.



System weight

The weight of the system depends on the dimensions of the installation. 2700 x 2700 mm installations has a system weight of approximately 7 kg/m² (including profile system).



Mechanical properties

No additional live load is allowed.



CE

Ecophon ceiling systems are CE marked according to the European harmonized standard EN 13964:2014. CE marked construction products are covered by a Declaration of Performance (DOP) which enables customers and users to easily compare performance of products available on the European market.

INSTALLATION DIAGRAM (M535) FOR ECOPHON AKUSTO WALL C EXTRA BASS VERTICAL INSTALLATION WITH CONNECT SHADOW PROFILES.

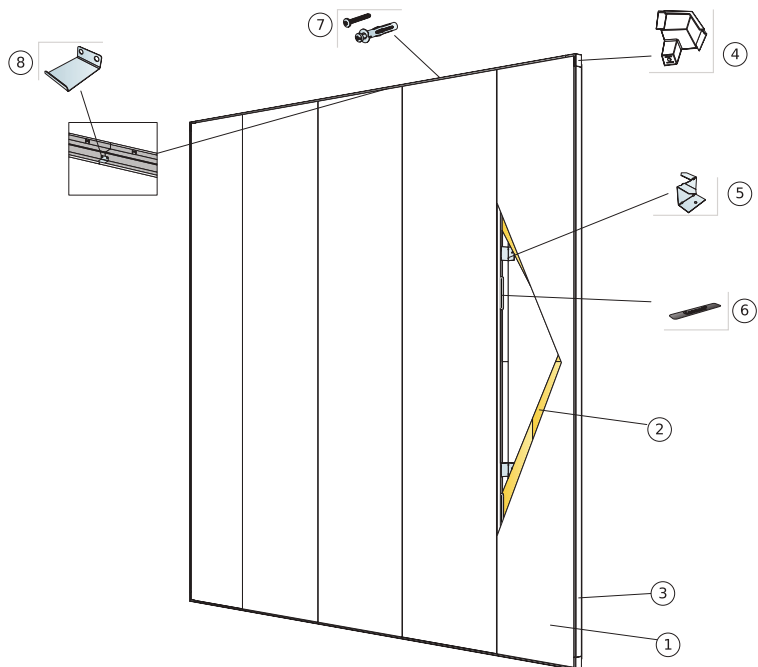

© Ecophon Group

QUANTITY SPECIFICATION (EXCL. WASTAGE)

	Size, mm
	2700x600
1 Akusto Wall C	0,62/m ²
2 Akusto Extra Bass	1,25/m ²
3 Connect Shadow Profile	as required
4 Connect Shadow Corner	as required
5 Connect Ambient fixing installed at 1000 mm centres	as required
6 Connect Spline	as required
7 Installation screw, installed at 200 mm centres (select fastener according to wall material)	as required
8 Connect Shadow Splice. Used to extend profiles where needed.	as required

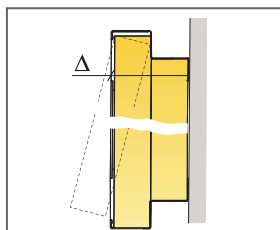

See Quantity specification

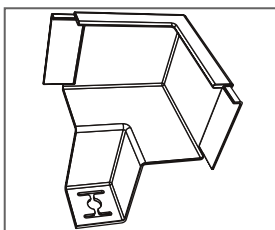

Detail of panel with Thinline system

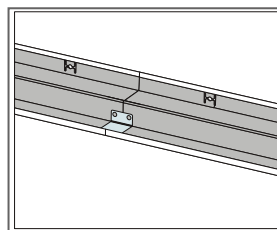

Detail of panel with Thinline system

INSTALLATION DIAGRAM (M547) FOR ECOPHON AKUSTO WALL BASS HORIZONTAL INSTALLATION WITH CONNECT SHADOW PROFILES.

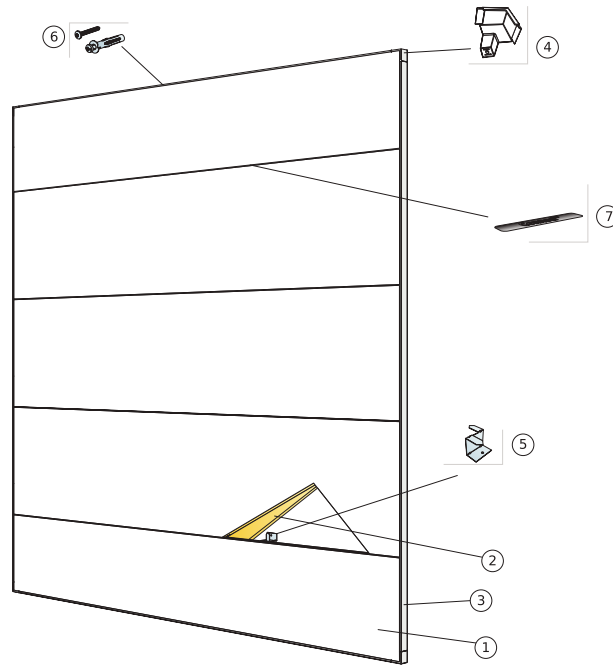

© Ecophon Group

QUANTITY SPECIFICATION (EXCL. WASTAGE)

	Size, mm
	2700x600
1 Akusto Wall C	0,62/m ²
2 Akusto Extra Bass	1,25/m ²
3 Connect Shadow Profile	as required
4 Connect Shadow Corner	as required
5 Connect Ambient fixing installed at 1000 mm centres	as required
6 Connect Spline	as required
7 Installation screw, installed at 200 mm centres (select fastener according to wall material)	as required
8 Connect Shadow Splice. Used to extend profiles where needed.	as required

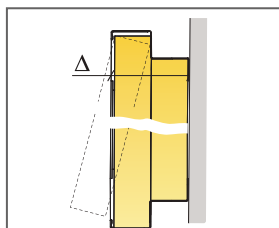

See Quantity specification

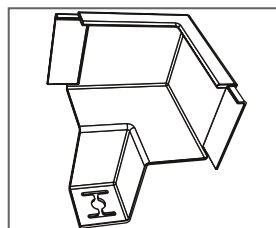

Detail of panel with Thinline system